

TABLE OF CONTENTS

	PAGE
WARRANTY	2
BE A SAFE OPERATOR	3-6
FORWARD	7
PARTS ORDERING INFORMATION	8
INSTALLATION & INTRODUCTION	9
ELECTRICAL TROUBLESHOOTING	10
ROUTINE MAINTENANCE	11
SERVICE TIPS & TECHNICAL BULLETIN	12-14
BALDOR MOTOR INFORMATION	15-19
SENTRY MILL SCREEN OPTIONS, BEATER HUB ASSEMBLY, DOOR ASSEMBLY AND GENERAL MILL INFORMATION	20-22

WARRANTY

The A. T. Ferrell Company, Inc. Manufacturer's Warranty for the following product lines:

MIX-MILL/FARMATIC

All Sentry Line Products

Sentry 100, Sentry 1000, Sentry 3000, Sentry 4000

(“MIX-MILL/FARMATIC” IS A REGISTERED TRADEMARK OF THE A. T. FERRELL COMPANY, INC.)

A. T. Ferrell Company, Inc. warrants each new product of its manufacture when purchased from an authorized representative for a period of one year from the date of shipment. This warranty shall apply to all parts and workmanship (except products or components not manufactured by the A. T. Ferrell Company, Inc.), which shall appear to A. T. Ferrell Company to have been defective in manufacture. The A. T. Ferrell Company's sole and entire obligation under such warranty shall be satisfied by shipment to the Purchaser-User, without charge, (except for transportation costs, which shall be paid by Purchaser-User) of the part or parts returned for inspection and parts intended to replace those acknowledged by A. T. Ferrell Company to be defective.

This warranty shall not apply and shall be void under the following conditions:

1. If the product is transported from its original installation site.
2. If any part of the product has been altered, modified or changed, except at A. T. Ferrell Company's factory or is authorized by A. T. Ferrell Company in writing.
3. If attachments or devices unsuitable to the product have been used on or in conjunction with the product.
4. If the product has not been installed, used, operated, handled or serviced in accordance with the appropriate instruction manual.

A.T. Ferrell Company reserves the right to make changes in design or improvements in its products without any obligation whatsoever to prior Purchaser-User of such products.

A.T. Ferrell Company will pass on to a Purchaser-User only such warranty as it shall receive on products or components not of its manufacture from the manufacturer or supplier thereof.

We will not be liable for any consequential damages, loss or expenses arising in connection with the use or inability to use the product for any purpose whatever. Our maximum liability shall not in any case exceed the cost of replacing defective parts if returned to us within one year from date of shipment. No salesman, manufacturer's representative or other person may make or has the authority to make any guarantees or warranties expressed or implied on behalf of A. T. Ferrell Company, Inc. which are inconsistent with these terms and conditions or any catalogue or other publication of A. T. Ferrell Company, Inc.

The Warranty Registration Card must be filled in completely and signed by Purchaser-User and returned to us to validate any warranty claim.

Claims for warranty should be directed to our sales department, 1440 South Adams Street, Bluffton, IN 46714 USA or phone (260) 824-5213. The machine serial number and description of the type of failure is required to file a claim. Contact our sales department before returning warranty items for a RMO (Returned Material Order) which must accompany all returned items. All returned items are to be shipped freight pre-paid and credit will be issued after inspection and acknowledgement of warranty defect. A. T. Ferrell Company, Inc. will pass on to the purchaser/user only such warranty as it shall receive on products or components not of its manufacture from the manufacturer or supplier thereof.

BE A SAFE OPERATOR

AVOID ACCIDENTS

Most accidents, whether they occur in industry, on the farm, at home, or on the highway, are caused by the failure of some individual to follow simple and fundamental safety rules or precautions. For this reason, most accidents can be prevented by recognizing the real cause and doing something about it before the accident occurs.

Regardless of the care used in the design and construction of any type of equipment, there are many conditions that cannot be completely safe guarded against without interfering with reasonable accessibility and efficient operation.

A careful operator is the best insurance against an accident.

The complete observance of one simple rule would prevent many serious injuries each year. That rule is:

Never attempt to clean, oil, or adjust a machine while it is in motion!
--National Safety Council

A.T. Ferrell has made every effort to provide safe equipment, however, the following precautions should be carefully observed!

1. Disconnect main service switch before removing any housing covers or electrical boxes or switches.
2. Ground the mill frame according to local electrical codes.
3. Ground any augers or feeders where livestock might contact either augers or feeders.
4. Keep all shields and covers in place.

BE A SAFE OPERATOR

AVOID ACCIDENTS

This safety alert symbol identifies important safety messages in this manual. When you see this symbol, be alert to the possibility of personal injury and carefully read the message that follows. Regardless of the care used in the design and construction of any type of equipment, there are many conditions that cannot be completely safeguarded against without interfering with reasonable accessibility and efficient machine operation. A careful operator is the best insurance against an accident.



Carefully read and understand the operators' manual before operating the machine. Do not attempt to install, connect power to, operate or service machine without proper instruction and until you have been thoroughly trained in its use by your employer.



Keep children, visitors and all untrained personnel away from machine while in operation.



Make certain all electric motors and control panels are properly grounded.



Danger – Do not attempt to work on, clean or service this equipment or open or remove any protective cover, guard, or grate until power has been turned off and mechanically locked out and the machine has come to a complete stop.



Danger – Keep hands, feet and clothing clear from rotating belts, pulleys, rolls and gears when machine is operating. Failure to do so will cause severe injury or death.



Danger – Never operate machine without protective covers, guards, or grates properly installed.



Do not obscure or remove safety decals from the equipment. Replacement decals are available from the manufacturer.



This equipment was manufactured in compliance with existing OSHA regulations. It is the responsibility of the owner/user to maintain OSHA compliance when operating the equipment.



If injured by escaping fluid, see a doctor at once.



Replace all guards and shields after servicing and before starting up the machine.



Do not clean, lubricate or adjust equipment while it is in operation.





After servicing, make sure all tools, parts and service equipment are removed from the machine.





Do not start the machine until you are sure that everyone is clear.

TYPICAL SAFETY DECALS

<p>⚠ DANGER</p> <p>Une tension dangereuse causera des blessures graves ou la mort. Couper l'alimentation et verrouiller avant de faire l'entretien.</p>		<p>⚠ DANGER</p> <p>Hazardous voltage will cause severe injury or death. Turn off power and lock out before servicing.</p>
©Clarion Safety Systems, LLC clarionsafety.com xxxxx		80003641 Reorder No. C18609-08

<p>⚠ DANGER</p> <p>La rotation des pales de ventilateur causera des coupures et l'écrasement. Verrouiller l'alimentation avant de retirer le couvercle ou la porte d'inspection.</p>		<p>⚠ DANGER</p> <p>Rotating fan blade will cut and crush. Lockout power before removing cover or inspection door.</p>
©Clarion Safety Systems, LLC clarionsafety.com xxxxx		80003642 Reorder No. C18609-09

<p>⚠ AVERTISSEMENT</p> <p>Les pièces mobiles peuvent écraser et couper. Verrouiller l'alimentation avant de retirer le dispositif de protection ou d'effectuer l'entretien.</p>		<p>⚠ WARNING</p> <p>Moving parts can crush and cut. Lockout power before removing guard or servicing. Do NOT operate with guard removed.</p>
©Clarion Safety Systems, LLC clarionsafety.com xxxxx		80003643 Reorder No. C18609-10

<p>⚠ AVERTISSEMENT</p> <p>Débrancher le système d'alimentation principal avant l'entretien! Le commutateur d'alimentation de chaque section contrôle uniquement cette section!</p>		<p>⚠ WARNING</p> <p>Disconnect main power before servicing! Each section's power switch controls that section only!</p>
©Clarion Safety Systems, LLC clarionsafety.com xxxxx		80006506 Reorder No. C18609-15

<p>⚠ DANGER</p> <p>Faire attention de ne pas se blesser. Les pièces mobiles peuvent écraser et couper. Garder les mains et les doigts à l'écart des pièces mobiles. Ne pas utiliser si le dispositif de protection a été retiré.</p>		<p>⚠ DANGER</p> <p>Avoid injury. Moving parts can crush and cut. Keep hands and fingers clear of moving parts. Do not operate with guard removed.</p>
©Clarion Safety Systems, LLC clarionsafety.com xxxxx		80006509 Reorder No. C18609-16

<p>⚠ AVERTISSEMENT</p> <p>Une installation, un réglage, un entretien ou une maintenance inappropriés peuvent causer des dommages matériels, des blessures corporelles ou la mort. Lire attentivement les instructions d'installation, d'utilisation et d'entretien avant d'installer ou d'effectuer l'entretien de cet équipement.</p>		<p>⚠ WARNING</p> <p>Improper installation, adjustment, service or maintenance can cause property damage, injury or death. Read the installation, operating and maintenance instructions thoroughly before installing or servicing this equipment.</p>
©Clarion Safety Systems, LLC clarionsafety.com xxxxx		F80003538 Reorder No. C18609-05

FORWARD

Thank you for purchasing a new **Mix-Mill** and/or Farmatic Sentry series mixer/grinder or roller mill. More than 50 years of experience in the manufacture of feed milling equipment and grain handling systems has made Mix-Mill/Farmatic the leader in the field of electric powered, on the farm feed conditioning systems.

Many of the features that have provided trouble free service for thousands of owners will still be found on your new Sentry Hammer Mill. New design technology and new components have also been incorporated in your mill to further increase the reliability and the flexibility needed for today's farming needs.

Some of these features are increased horsepower sizes, state of the art electronics, new type C frame motors, larger screen and grinding chamber size. A new beater hub design, with these other features, gives you more output per hour to get the job done faster and more efficient.

We prepared this booklet for our Sentry Hammer Mill to help you install, operate and maintain your mill to the highest standard and to obtain the greatest efficiency.

If a commercial carrier shipped your mill, ensure that you check all parts carefully to see if there is any damage in the shipping. If damage is found, make a notation of such and make certain that your local agent makes a similar note on your freight bill, before you accept shipment. This is necessary to support your claim. Do not hesitate to accept damaged equipment after the agent has made the notation on the freight bill. You will be reimbursed when you present your claim. We assume no responsibility for loss or damages after the equipment leaves our dock, but we will gladly render our services to assist you in adjusting your claim. Determine the parts you require, submit an order to us and we will prepare an invoice. Upon receiving our invoice you will be in a position to file a claim against the shipping company.

The following pages of this owner's manual will provide you with the correct operating information and answer many of your questions about your new Sentry Hammer Mill. Please take a few minutes to read these instructions and keep them for future references

The parts breakdown will help you to obtain genuine factory parts when needed. Please contact your local authorized dealer any time you need parts or service. He can also provide you with other equipment and help you plan for future growth.

A.T. Ferrell Company, Inc.
Mix-Mill Division

Mix-Mill

Division of A. T. Ferrell Company, Inc.

PARTS ORDERING INFORMATION

1. Order replacements parts through your local sales representative or direct from Mix-Mill.

A. T. Ferrell Company, Inc.
1440 S. Adams St.
Bluffton, IN 46714 U.S.A.
Phone: (260) 824-5213 (800) 537-6260
Fax: (260) 824-5463
Website: www.mix-mill.com
E-Mail: info@atferrell.com

2. To expedite the order process, please have your machine description, model number, and serial number available.
3. Use the part numbers and descriptions furnished in this manual.

INSTALLATION AND OPERATION

New Installation Requirements

The mixer/grinder must be in a weatherproof structure.

Existing Installations

Some existing farm structures are suitable for mill installation. See your authorized dealer and let him work with you to develop the most efficient, most economical system for your needs.

Mill Capacities

Several factors must be considered when figuring mill capacities: the type and amount of each ingredient, the amount of material ground and the amount that is bypassed, mill horsepower and screen size. An undersized discharge system can be a limiting factor on mill capacity. Hardness and variations in the hardness of different grains will have an effect on the mill capacity and in the amount of wear to replaceable parts such as screens, hub and hammers and mill wear plates.

Installation Procedures

WARNING!!

Failure to properly ground this machine could lead to serious injury to animals or persons operating the equipment. Grounding of all equipment is recommended. Grounding should be in accordance with the national electrical code and should be consistent with should local practice.

Before attempting repairs to any equipment, disconnect and "**lock out**" the incoming power to that equipment. An electrical shock can be obtained from an electric motor even though the incoming power is shut off. This could be caused by capacitor discharge in single phase or capacitor type motors.

ELECTRICAL TROUBLESHOOTING

Symptom	Probable Cause	Corrective Action
Motor will not start	Bad connection in display strap	See “Partial Clock/Counter display.”
	Failed contactor	Check for contactors not engaging during cycle-up. Test and replace if necessary.
	Blown motor fuse	Check and replace fuses. Inspect motor for cause of overload.
	Loose connection	Tighten all motor wiring.
	Failed motor	Test and replace if necessary.
Frequent motor overload	Mechanical obstruction	Remove obstruction. Check bearings.
	Loose connection	Tighten all motor Wiring.
	Failed contactor	Test and replace if necessary.
	Low overload	Check overload adjustment against motor’s full load amperage.

ROUTINE MAINTENANCE

1. Check hammers for wear weekly or every 15 hours of operation whichever occurs first.
2. When changing hammers check bolts for wear.
3. Check screen for wear weekly or every 15 hours of operation whichever occurs first.
4. Check door seals monthly.
5. Check all belts for alignment and tension weekly.
6. Check mill magnets for tramp iron daily.
7. All electrical connections should be checked one month after installation, six months after installation and once a year thereafter.
8. Check proportioner auger for build up weekly and clean as necessary, build up on augers can severely affect calibration.

SERVICE TIPS

Screen and Wear Plates

The screen and wear plates have been designed so that you can get 18 different adjustments per side for extended screen life.

Hammers

The hammers, spacers and hammer bolts are replaceable items. The hammers can be reversed (using the reversing switch of single phase mills) to double their life. They can also be moved in sets of three from the point of grain entry to the back of the housing for additional life. When changing their location, care must be exercised to keep the hammers in their original sets of three to prevent imbalance. It is of great importance to inspect the hammers to see that they are wearing properly. Figure # 6 illustrates normal wear of a worn out hammer. To get the maximum life out of your hammers you should reverse the direction of travel (with reversing switch on single phase mills) or rotate the hammer 180 degrees when it wears to the middle of the end tip. The other side can be worn down to the same point, but after the length of the hammer has been affected the hammer is then wore out as illustrated in figure # 6.

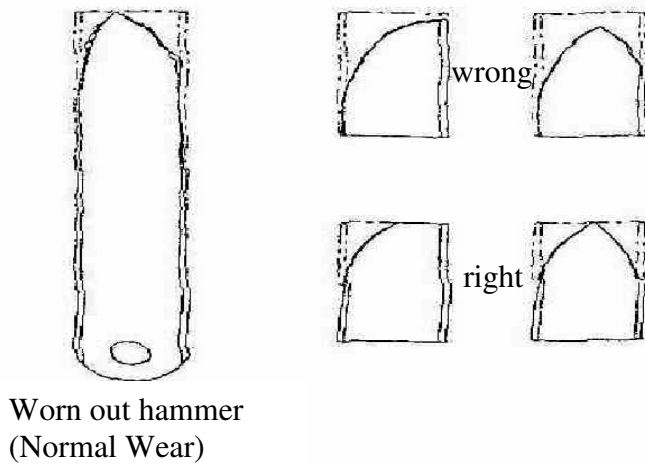

Figure 6

By continually using a worn out hammer it could cause the following:

1. Poor quality of ground feed due to inconsistent particle size.
2. Loss in grinding capacity, therefore causing higher cost per ton to process feed.
3. Motor bearing failure due to vibration.
4. Screen and housing damage due to broken hammer.

PLEASE NOTE:

Vibration is hard on the motor bearings and can cause premature failure. An out of balance condition can result from vibration caused by a broken hammer.

PLEASE NOTE:

Do not use an impact wrench when tightening the 3 hub bolts, this will cause the hub to be off balance and cause vibration. Use a 7/16" ratchet & socket set and use equal torque.

When tightening nuts on the hammer bolts, they should be tight enough so that the hammers cannot swing freely but can still be moved with hand pressure.

Vibration can be caused by uneven wear of the hammer on the hammer bolts. The wear is not always uniform, in spite of carefully controlled heat-treating of the hammers and bolts. The bolts that wears the fastest permits the hammers to move farther from the center of rotation, causing imbalance. It is important that you carefully examine hammer bolts for wear replacing a set of hammers.

The cost of hammer replacement is inexpensive when compared to the damage that can occur by using worn out hammers.

TECHNICAL BULLETIN

In order to accommodate different grinding requirements and different raw materials we have modified our Sentry Mill hubs to allow the end user to easily adjust the clearance between the tip of the hammers and the screen.

Instead of the original six holes punched in the hub washers the new washers will have twelve holes in four sets of three, each different set is a different diameter. The matching holes marked with one Dot mark is the original diameter of the older hubs. Each successive set of holes marked with two, three, or four Dots; moves the hammers approx 3/32 of an inch closer to the screen.

CAUTION!!

When moving hammers to different sets of holes it is critical to maintain balance by placing the hammers evenly spaced around the hub. To confirm balance, **be sure the hammers are in positions with the same numbers of marks**. Also before starting the mill, rotate hub by hand to ensure that the hammers do not contact the screen at any point.

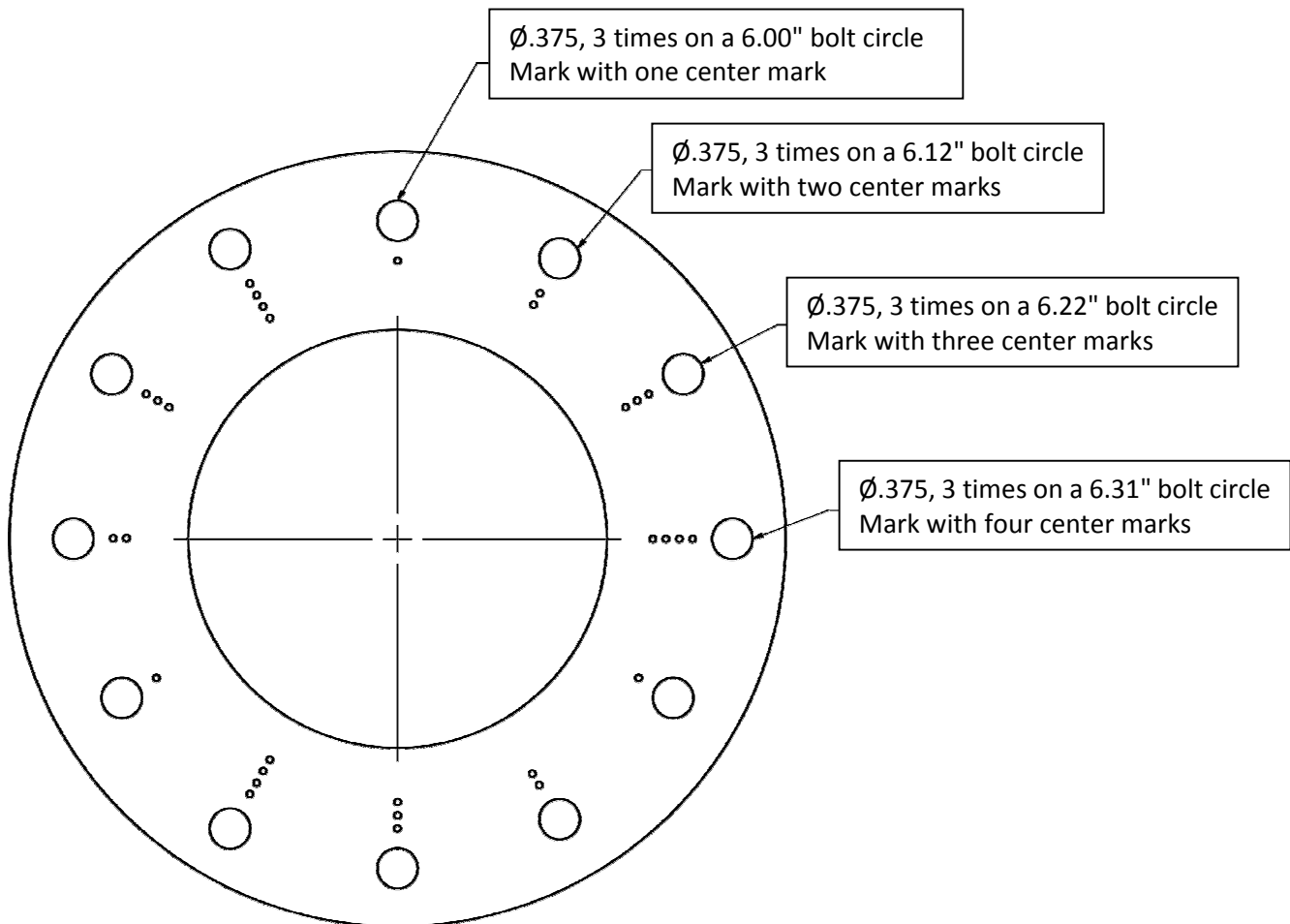

BALDOR MOTOR INFORMATION

AC & DC Motor Installation & Maintenance NEMA (IEC) Frames to 320 (200)

Before you install, operate or perform maintenance, become familiar with the following:

- NEMA Publication MG-2, Safety Standard for Construction and guide for Selection, Installation and Use of Electric Motors and Generators.
- IEC 60072-1 Electrical and IEC72-1 Mechanical specifications
- ANSI C51.5, the National Electrical Code (NEC) and local codes and practices.

Receiving Each Baldor Electric Motor is thoroughly tested at the factory and carefully packaged for shipment. When you receive your motor, there are several things you should do immediately.

1. Observe the condition of the shipping container and report any damage immediately to the commercial carrier that delivered your motor.
2. Verify that the part number of the motor you received is the same as the part number listed on your purchase order.

Handling The weight of the motor and shipping container will vary. Use correct material handling equipment to avoid injury. Use caution when removing the motor from its packaging. Sharp corners may exist on motor shaft, motor key, sheet metal and other surfaces.

Safety Notice

Only qualified personnel trained in the safe installation and operation of this equipment should install this motor. When improperly installed or used, rotating equipment can cause serious or fatal injury. Equipment must be installed in accordance with the National Electrical Code (NEC), local codes and NEMA MG2 Safety Standards for Construction and Guide for Selection, Installation and Use of Electric Motors and Generators.

Observe the following guidelines:

1. Connect Power and Ground to the motor according to NEC or IEC and local codes.
2. Provide a permanent guard to prevent accidental contact of body parts or clothing with rotating or moving parts or burns if motor is hot.
3. Shaft key must be secured before starting motor.
4. Mounting bolts should be high tensile steel. Be sure to use a suitable locking device on each bolt (spring washer or thread lock compound).
5. Do not apply power to the motor until the motor is securely mounted by its mounting holes.
6. This motor must only be connected to the proper line voltage, line frequency and load size.
7. Motors are not to be used for load holding or restraining unless a properly sized brake is installed. If a motor mounted brake is installed, provide proper safeguards in case of brake failure.
8. Disconnect all power services, stop the motor and allow it to cool before servicing.
9. For single phase motors, discharge the start and/or run capacitors before servicing.
10. Do not by-pass or render inoperative any safety device.
11. DC series wound motors must be protected from sudden loss of load causing overspeed damage. DC shunt wound motors must be protected from loss of field voltage which can result in damage.
12. When using AC motors with frequency inverters, be certain that the motors Maximum Speed Rating is not exceeded.

Guarding

After motor installation is complete, a guard of suitable dimensions must be constructed and installed around the motor/gearmotor. This guard must prevent personnel from coming in contact with any moving parts of the motor or drive assembly but must allow sufficient cooling air to pass over the motor. If a motor mounted brake is installed, provide proper safeguards for personnel in case of brake failure. Brush inspection plates and electrical connection cover plates or lids, must be installed before operating the motor.

WARNING: Guards must be installed for rotating parts such as couplings, pulleys, external fans, and unused shaft extensions, should be permanently guarded to prevent accidental contact by personnel. Accidental contact with body parts or clothing can cause serious or fatal injury.

When this motor is installed according to these instructions, it complies with the EEC Machinery Directive. Electromagnetic Compatibility (EMC) requirements for CE compliance are met when the incoming power is purely sinusoidal. For other power source types, refer to MN1383 "Recommended Practices for Installation for EC Directive 89/336/EEC Relating to EMC".

Motor Enclosure

ODP, **Open drip proof** motors are intended for use in clean, dry locations with adequate supply of cooling air. These motors should not be used in the presence of flammable or combustible materials. Open motors can emit flame and/or molten metal in the event of insulation failure.

TEFC, **totally enclosed** motors are intended for use where moisture, dirt and/or corrosive materials are present in indoor and outdoor locations.

Explosion proof motors, as indicated by the Underwriters Laboratories, Inc. label are intended for use in hazardous areas as specified by the NEC.

Mounting

Foot mounted machines should be mounted to a rigid foundation to prevent excessive vibration. Shims may be used if location is uneven.

Flange mounted machines should be properly seated and aligned. Note: If improper rotation direction is detrimental to the load, check rotation direction prior to coupling the load to the motor shaft.

For **V-belt drive**, mount the sheave pulley close to the motor housing. Allow clearance for end to end movement of the motor shaft. Do not overtighten belts as this may cause premature bearing failure or shaft breakage.

Direct coupled machines should be carefully aligned and the shaft should rotate freely without binding.

Wiring

Connect the motor as shown in the connection diagram. If this motor is installed as part of a motor control drive system, connect and protect the motor according to the control manufacturers diagrams. Refer to MN408 for additional details on lead marking (see http://www.baldor.com/support/product_manuals.asp). The wiring, fusing and grounding must comply with the National Electrical Code or IEC and local codes.

When the motor is connected to the load for proper direction of rotation and started, it should start quickly and run smoothly. If not, stop the motor immediately and determine the cause. Possible causes are: low voltage at the motor, motor connections are not correct or the load is too heavy. Check the motor current after a few minutes of operation and compare the measured current with the nameplate rating.

Grounding

Ground the motor according to NEC and local codes. In the USA consult the National Electrical Code, Article 430 for information on grounding of motors and generators, and Article 250 for general information on grounding. In making the ground connection, the installer should make certain that there is a solid and permanent metallic connection between the ground point, the motor or generator terminal housing, and the motor or generator frame. In non-USA locations consult the appropriate national or local code applicable.

Adjustment

The neutral is adjustable on some DC motors. AC motors have no adjustable parts.

Noise

For specific sound power or pressure level information, contact your local Baldor representative.

Vibration

This motor is balanced to NEMA MG1, Part 7 standard.

Brushes (DC Motors)

Periodically, the brushes should be inspected and all brush dust blown out of the motor. If a brush is worn $\frac{1}{2}$ " (from length specified in renewal parts data), replace the brushes. If the commutator is worn or rough, the armature should be removed. The commutator should be turned in a lathe, the mica recut and the commutator polished. Reassemble and seat the new brushes using a brush seating stone. Be sure the rocker arm is set on the neutral mark.

Lubrication Information

This is a ball or roller bearing motor. The bearings have been lubricated at the factory. Motors that do not have regrease capability are factory lubricated for the normal life of the bearings.

Lubricant

Baldor motors are pregreased, normally with Polyrex EM (Exxon Mobil). If other greases are preferred, check with a local Baldor Service Center for recommendations.

Relubrication Intervals (For motors with regrease capability)

New motors that have been stored for a year or more should be relubricated.

Lubrication is also recommended at these intervals:

Table 1 Relubrication Interval

NEMA (IEC) Frame Size	Rated Speed (RPM)			
	3600	1800	1200	900
Up to 210 incl. (132)	5500Hrs.	12000Hrs.	18000Hrs.	22000Hrs.
Over 210 to 280 incl. (180)	3600Hrs.	9500Hrs.	15000Hrs.	18000Hrs.
Over 280 to 320 incl. (200)	*2200Hrs.	7400Hrs.	12000Hrs.	15000Hrs.

Table 2 Service Conditions

Severity of Service	Ambient Temperature Maximum	Atmospheric Contamination	Type of Bearing
Standard	40° C	Clean, Little Corrosion	Deep Groove Ball Bearing
Severe	50° C	Moderate dirt, Corrosion	Ball Thrust, Roller
Extreme	>50° C* or Class H Insulation	Severe dirt, Abrasive dust, Corrosion	All Bearings
Low Temperature	<-30° C**		

* Special high temperature grease is recommended.

** Special low temperature grease is recommended.

Table 3 Lubrication Interval Multiplier

Severity of Service	Multiplier
Standard	1.0
Severe	0.5
Extreme	0.1
Low Temperature	1.0

Table 4 Amount of Grease to Add

Frame Size NEMA (IEC)	Bearing Description (Largest bearing in each frame size)					
	Bearing	OD D mm	Width B mm	Weight of grease to add ounce (gram)	Volume of grease to add	
					inches ³	teaspoon
Up to 210 incl. (132)	6307	80	21	0.30 (8.4)	0.6	2.0
Over 210 to 280 incl. (180)	6311	120	29	0.61 (17.4)	1.2	3.9
Over 280 to 320 incl. (200)	6313	140	33	0.81 (23.1)	1.5	5.2

Weight in grams = 0.005 DB

Maintenance Procedures

WARNING: Do not touch electrical connections before you first ensure that power has been disconnected. Electrical shock can cause serious or fatal injury.

WARNING: Surface temperatures of motor enclosures may reach temperatures which can cause discomfort or injury to personnel accidentally coming into contact with hot surfaces. Protection should be provided by the user to protect against accidental contact with hot surfaces. Failure to observe this precaution could result in bodily injury.

Lubrication Procedure

Caution: Keep grease clean. Mixing dissimilar grease is not recommended.

1. Relubrication with the shaft stationary and a warm motor is recommended.
2. Remove all dirt and wipe clean the outside of the grease fills and drains.
3. Clean the grease fitting (or area around grease hole, if equipped with slotted grease screws). If motor has a purge plug, remove it. Motors can be regreased while stopped (at less than 80°C) or running.
4. Locate the grease inlet at the top of the bearing hub, clean the area and replace the 1/8-inch pipe plug with a grease fitting if the motor is not equipped with grease fitting.
5. Remove grease drain plug located opposite the grease inlet.
6. Apply grease gun to fitting (or grease hole). Too much grease or injecting grease too quickly can cause premature bearing failure. Slowly apply the recommended amount of grease, taking 1 minute or so to apply.
7. Operate motor for 20 minutes, reinstall purge plug if previously removed.
8. Install grease drain plug located opposite the grease inlet.

Sample Relubrication Determination

This sample determination is based on a NEMA 286T (IEC 180) motor operating at 1750 RPM driving an exhaust fan in an ambient of 43°C atmosphere that is moderately corrosive.

1. Table 1 list 9500 hours for standard conditions.
2. Table 2 classifies severity of service as "Severe".
3. Table 3 lists a multiplier value of 0.5 for Severe conditions.
4. Table 4 shows that 1.2 in³ or 3.9 teaspoon of grease is to be added.

Note: Smaller bearings in size category may require reduced amounts of grease.



World Headquarters

P.O. Box 2400 Fort Smith, AR 72902-2400 USA Ph: (1) 479.646.4711, Fax: (1) 479.648.5792
www.baldor.com

© 2009 Baldor Electric Company
LB5040

All rights reserved. Printed in USA
5/09

Sentry Screen Options

<u>Part number</u>	<u>Quantity</u>	<u>Description</u>
92000208	1	18" diameter screen with 1/16" holes
92000209	1	18" diameter screen with 7/64" holes
92000211	1	18" diameter screen with 5/32" holes
92000212	1	18" diameter screen with 3/16" holes
92000213	1	18" diameter screen with 7/32" holes
92000214	1	18" diameter screen with 1/4" holes
92000215	1	18" diameter screen with 5/16" holes
92000216	1	18" diameter screen with 3/8" holes
92000217	1	18" diameter screen with 7/16" holes
92000218	1	18" diameter screen with 1/2" holes
92000219	1	18" diameter screen with 5/8" holes
92000220	1	18" diameter screen with 3/4" holes
92000221	1	18" diameter screen with 1/8" holes
92001070	1	18" diameter screen with 9/64" holes
92001071	1	18" diameter screen with 3/32" holes

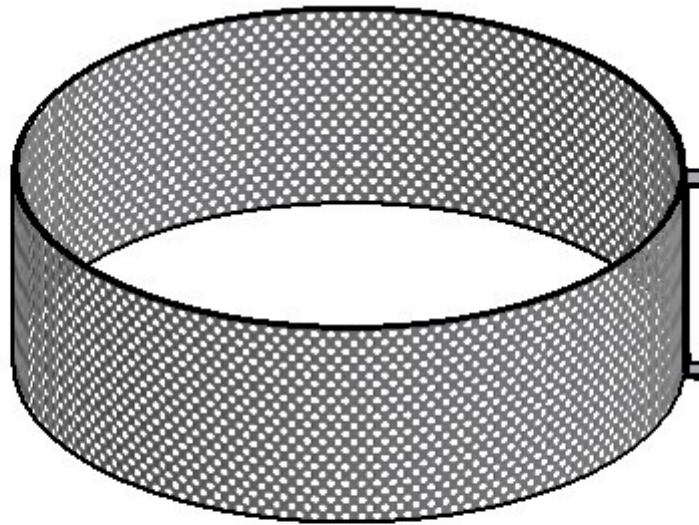

Beater Hub Assembly

Complete part # 92000234

<u>Item #</u>	<u>Part number</u>	<u>Quantity</u>	<u>Description</u>
1	90000104	1	Beater hub welded assembly
2	92000278	1	Hammers (set of 15)
3	80013502	6	Hub spacer
4	80013501	12	Hub spacer
5	70011504	3	3/8-24 Hub Stud
6	66754500	3	3/8-24 Jam Nut
7	66443300	3	1/4 lock washer
8	62583322	3	HHCS 1/4-20 x 1

Note: Items # 3 and 4 are packaged together in part number 92000582

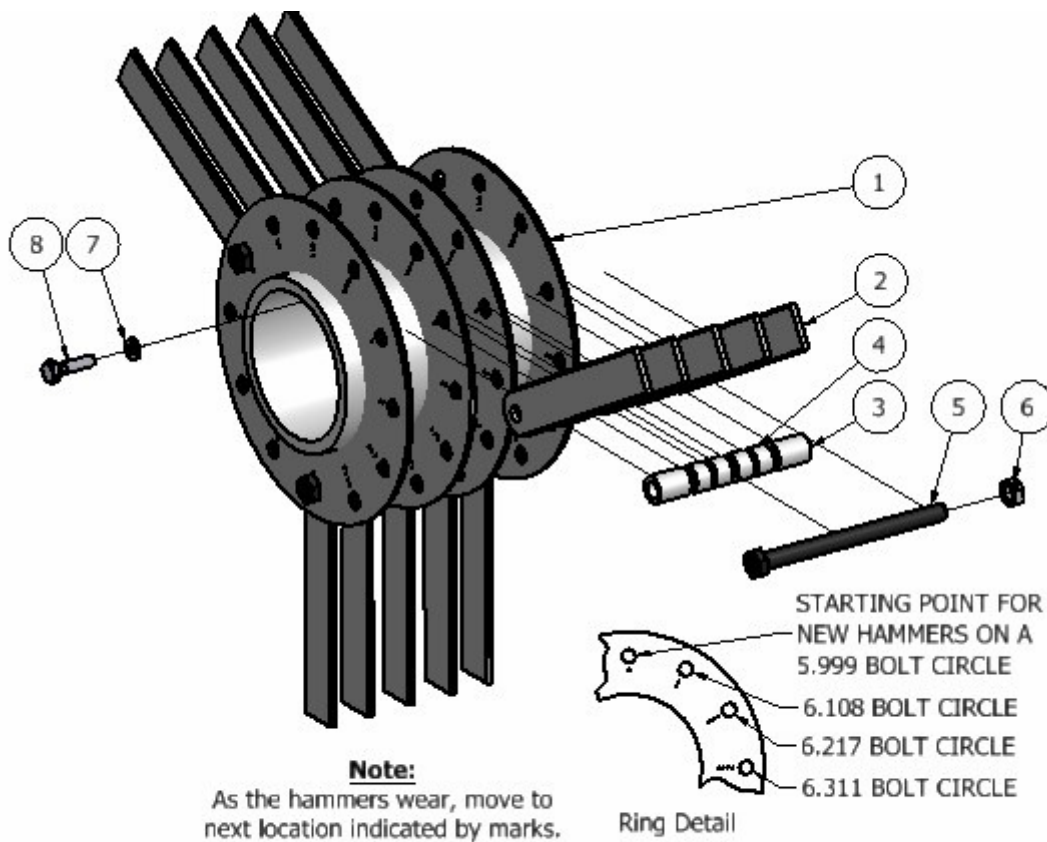

Door Assembly - Sentry 1000

Complete part # 92000806

<u>Item #</u>	<u>Part number</u>	<u>Quantity</u>	<u>Description</u>
1	60283317	6	1/4-20x3/4 carriage bolt
2	65483317	2	Hex Slit HD T/C1/4-20 x 3/4"
3	66083300	6	1/4-20 hex nut
4	66403300	6	1/4 flat washer
5	66443300	6	1/4 lock washer
8	80008001	2	Magnet, Mill, Ceramic Steel
9	80014002	7.5ft	Tape, polyurethane 3/8x1/2
10	90000440	1	Wear plate Wldmt, D-Mill
11	90000874	1	Door Wldmt, Grinder, Sentry/D mill

