

REVISION HISTORY				
REV	ECN	DESCRIPTION	DATE	APPROVED
A	XXXXXX	RELEASE	11/9/1951	Loehr
B	F120129	WAS C SIZE GROUP DRAWING, F03500340 WAS F03500310	12/5/2012	dmjohnson

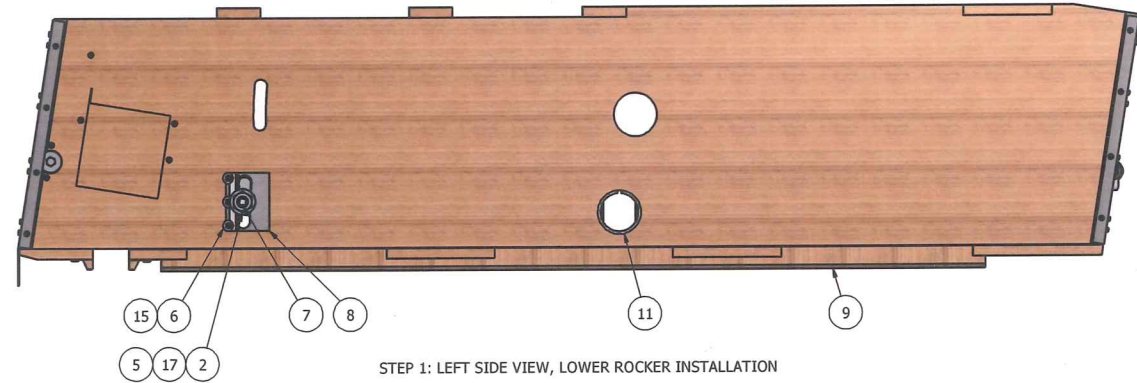

STEP 1: LEFT SIDE VIEW, LOWER ROCKER INSTALLATION

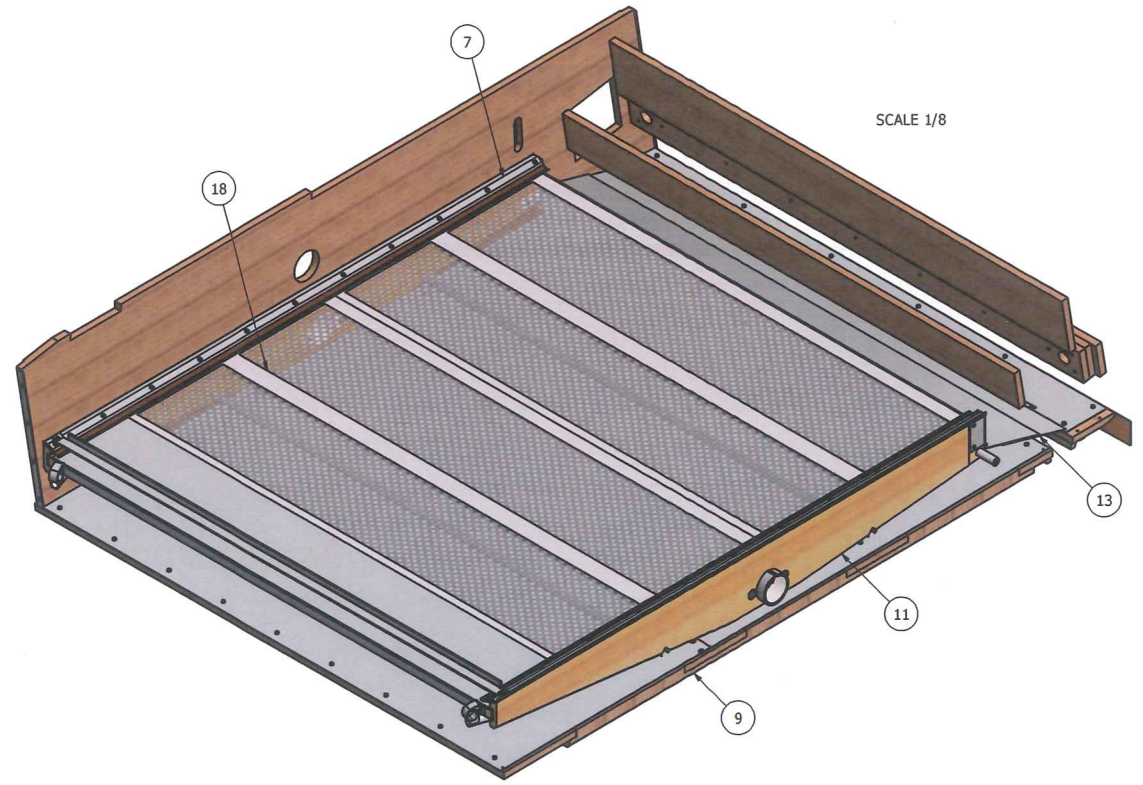

SCALE 1/8

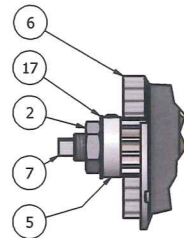

DETAIL A
SCALE 0.38 : 1

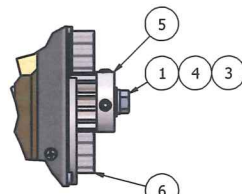

DETAIL B
SCALE 0.38 : 1

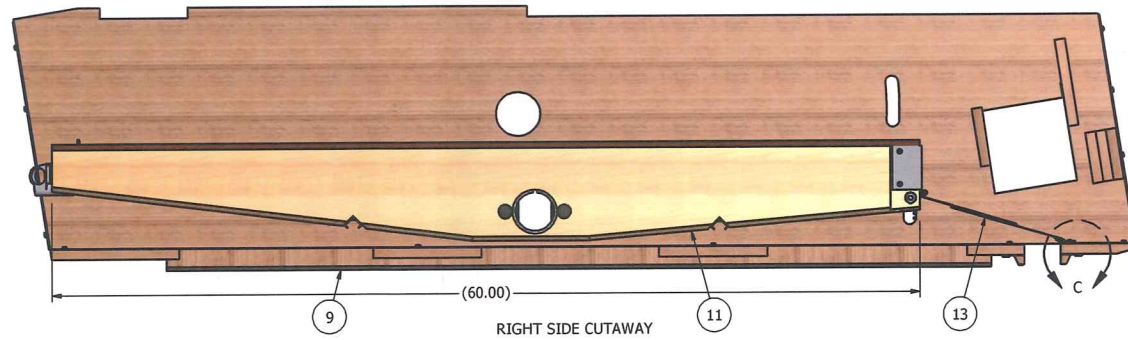

RIGHT SIDE CUTAWAY

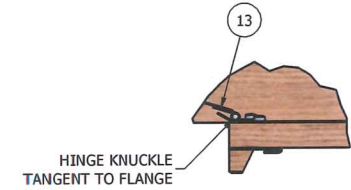

HINGE KNUCKLE
TANGENT TO FLANGE

DETAIL C
SCALE .38:1

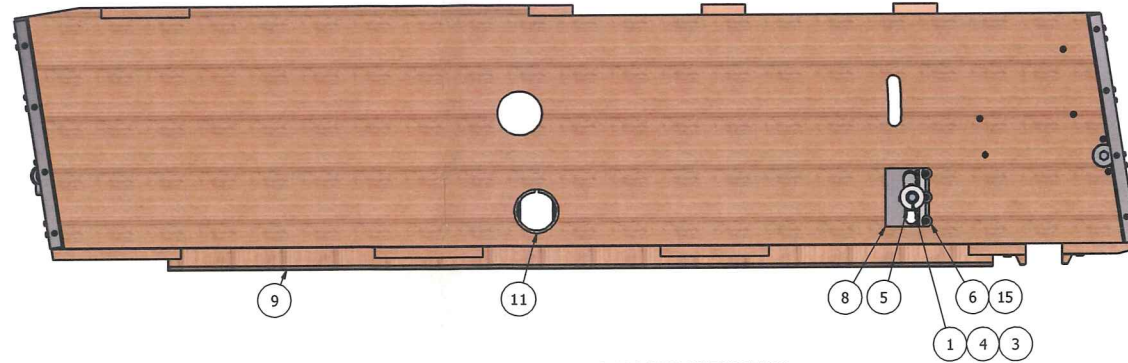
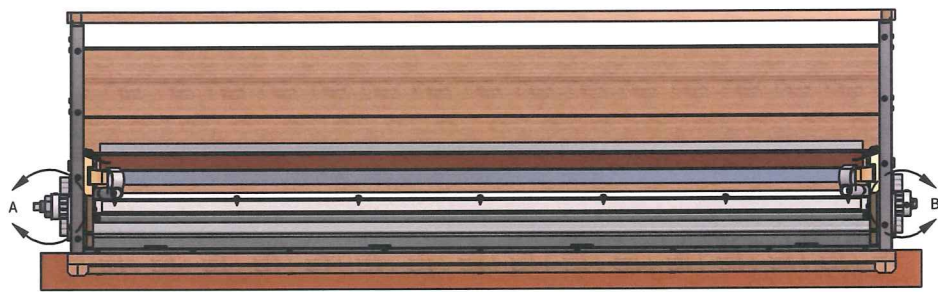

STEP 1: RIGHT SIDE VIEW, BOTTOM ROCKER INSTALLATION

ITEM	PART NUMBER	QTY	DESCRIPTION
* 18	SALES ORDER	2	FRAME ASSY, PERF SCREEN, 60" X #8
17	F84621034	2	WASHER, FLT .750 X 1.750 X .062
16	F83451201	11	SMS, PAN X HD, #8 X 1/2"
15	F83450101	12	SMS, PAN X HD, #8 X 1.00"
* 14	F08308801	1	SPOUT, LH STRAW, X298
13	F03804976	1	APRON ASSY, TELESCOPING, BTM ROCKER, 68D
12	F03804975	1	APRON ASSY, TELESCOPING, TOP ROCKER, 68D
11	F03500340	1	ROCKER ASSY, BOTTOM, BOTTOM SHOE, 68A & D
10	F03500210	1	ROCKER ASSY, TOP, BOTTOM SHOE, 298D
9	F03008110	1	SHOE ASSY, BOTTOM LH, 68A & D
8	F01801700	4	PLATE, ESCUTHCHEON, TILT ROD ROCKER
7	F01608303	2	SHAFT, TILTING ROD, 3/4 X 60.50" #8
6	F01200300	4	RACK, STRAIGHT ROCKER ADJUSTING
5	F01200203	4	PINION, BRUSH ADJ. 13 TOOTH W/SET SCREWS
4	66444400	2	WASHER, LOCK HELICAL 3/8"
3	66404400	2	WASHER, FLAT 3/8" NARROW TYPE A
2	66276400	2	NUT, HEAVY HEX JAM 3/4-10
1	62584422	2	HHCS, 3/8-16 X 1.00"

- NOTES:
 1. DO NOT SCALE FROM DRAWING.
 2. ONE PIECE REQUIRED PER F40400681/83: CLEANER ASSY, LH BT 900RPM W/O VSS / W/ VSS, 68D.
 3. * LINE ITEM ON SALES ORDER. NOT INCLUDED IN BILL OF MATERIAL.

		DIVISION OF A.T.FERRELL COMPANY 1440 S ADAMS ST BLUFFTON, INDIANA 46714 - USA PH: 260-624-3400 FAX: 260-824-5465		This drawing is the property of the A.T. Ferrell Company, Inc and must be returned immediately upon request. No part of this drawing may be reproduced, stored in a retrieval system or transmitted in any form or by any means, without prior written consent of the A.T. Ferrell Company, Inc.	
TOLERANCES EXCEPT AS NOTED DECIMAL: XX ± .030 XXX ± .005 XXXX ± .001		FRACTIONAL: ± 1/32 ANGULAR: ± 1/2°		TITLE: SHOE ASSY, LH BOTTOM W/ROCKERS, 68A & D FINISH: NONE	
CAD NO MANUAL CHANGES		SCALE: 0.16:1		SHEET: 1 OF 2 SIZE: D PART NUMBER: F03008106 REV: B	

REVISION HISTORY				
REV	ECN	DESCRIPTION	DATE	APPROVED
A	XXXXXX	RELEASE	11/9/1951	Loehr
B	F120129	WAS C SIZE GROUP DRAWING, F03500340 WAS F03500310	12/5/2012	dmjohnson

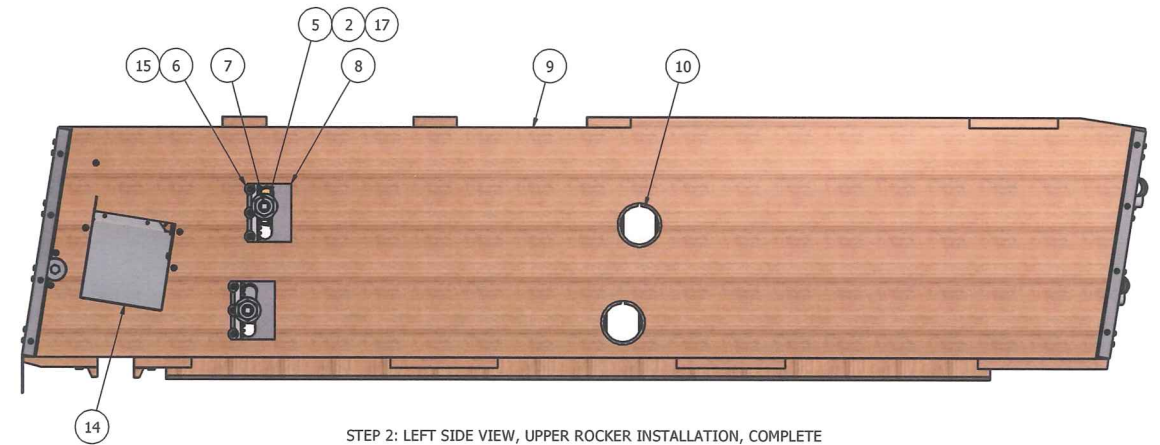

STEP 2: LEFT SIDE VIEW, UPPER ROCKER INSTALLATION, COMPLETE

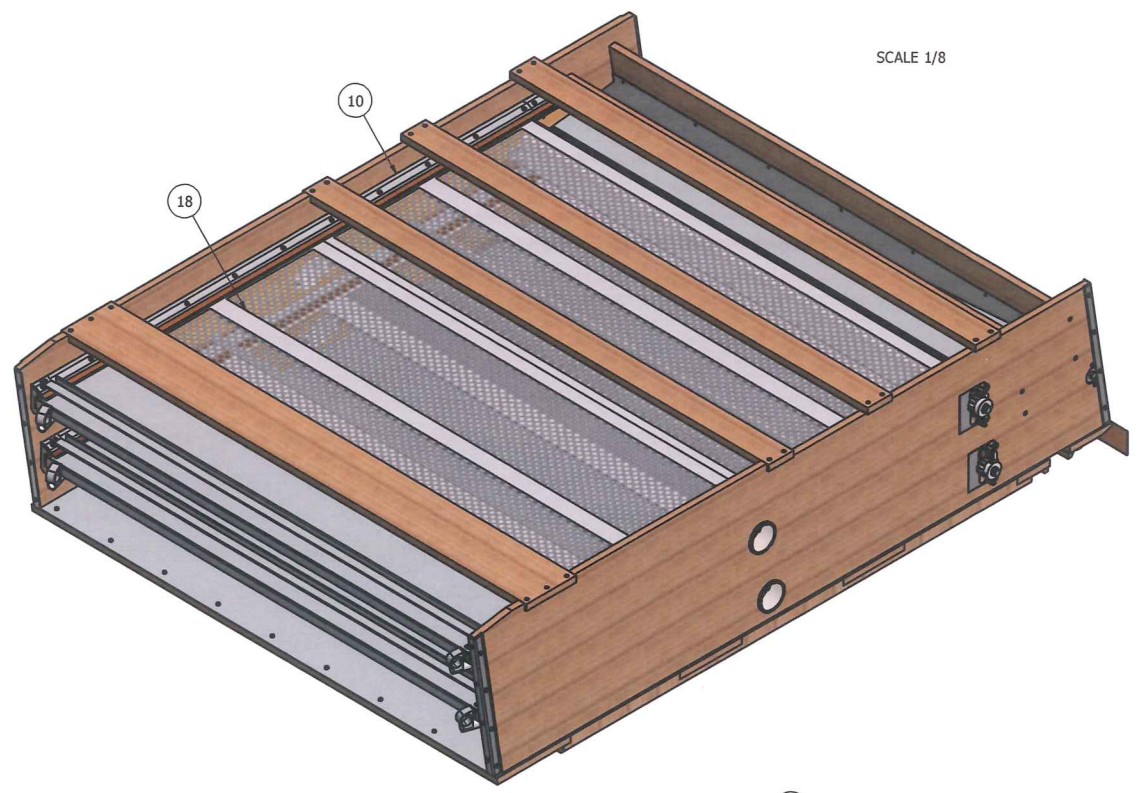

SCALE 1/8

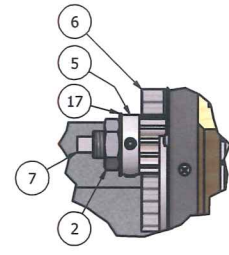

DETAIL D
SCALE 0.38 : 1

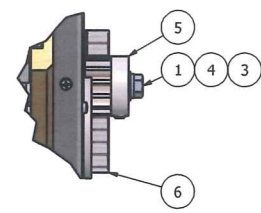

DETAIL E
SCALE 0.38 : 1

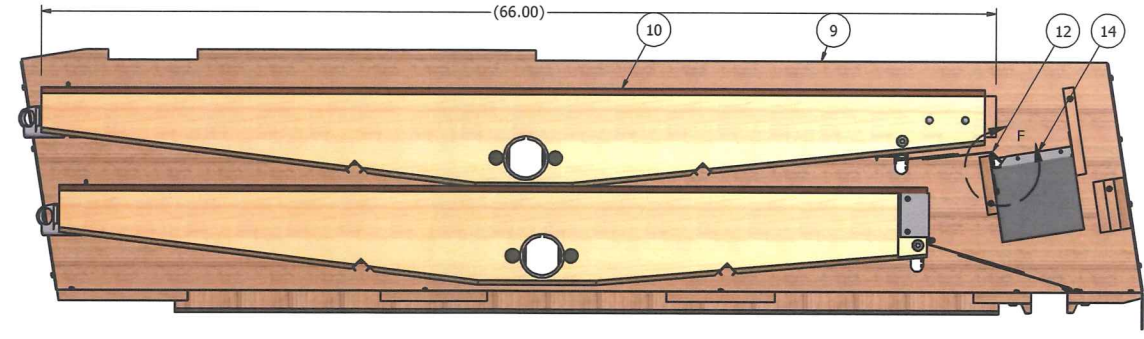

RIGHT SIDE CUTAWAY

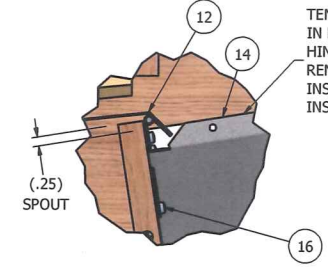

DETAIL F
SCALE 0.38 : 1

TEMPORARILY MOUNT SPOUT IN PLACE. LOCATE & DRILL APRON HINGE HOLES THRU SPOUT. REMOVE SPOUT. APRON & SPOUT INSTALLED AFTER SHOE INSTALLED IN FRAME.

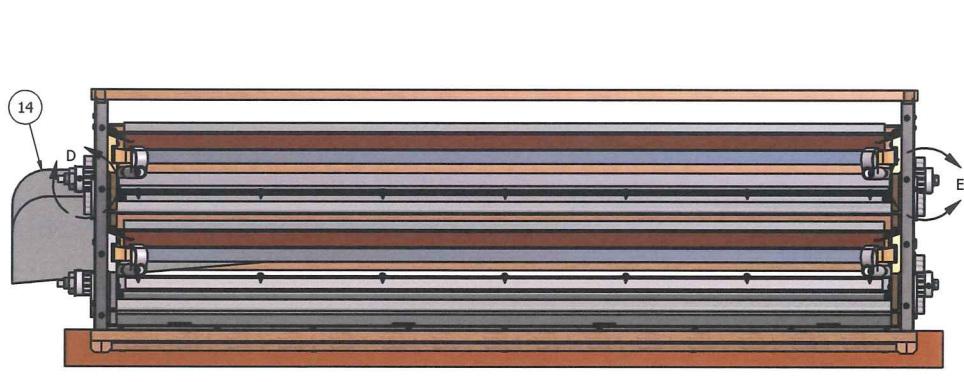

STEP 2: RIGHT SIDE VIEW, UPPER ROCKER INSTALLATION

ITEM	PART NUMBER	QTY	DESCRIPTION
* 18	SALES ORDER	2	FRAME ASSY, PERF SCREEN, 60" X #8
17	F84621034	2	WASHER, FLT .750 X 1.750 X .062
16	F83451201	11	SMS, PAN X HD, #8 X 1/2"
15	F83450101	12	SMS, PAN X HD, #8 X 1.00"
* 14	F08308801	1	SPOUT, LH STRAW, X298
13	F03804976	1	APRON ASSY, TELESCOPING, BTM ROCKER, 68D
12	F03804975	1	APRON ASSY, TELESCOPING, TOP ROCKER, 68D
11	F03500340	1	ROCKER ASSY, BOTTOM, BOTTOM SHOE, 68A & D
10	F03500210	1	ROCKER ASSY, TOP, BOTTOM SHOE, 298D
9	F03008110	1	SHOE ASSY, BOTTOM LH, 68A & D
8	F01801700	4	PLATE, ESCUTCHCHEON, TILT ROD ROCKER
7	F01608303	2	SHAFT, TILTING ROD, 3/4 X 60.50" #8
6	F01200300	4	RACK, STRAIGHT ROCKER ADJUSTING
5	F01200203	4	PINION, BRUSH ADJ. 13 TOOTH W/SET SCREWS
4	66444400	2	WASHER, LOCK HELICAL 3/8"
3	66404400	2	WASHER, FLAT 3/8" NARROW TYPE A
2	66276400	2	NUT, HEAVY HEX JAM 3/4-10
1	62584422	2	HHCS, 3/8-16 X 1.00"

NOTES:
 1. DO NOT SCALE FROM DRAWING.
 2. ONE PIECE REQUIRED PER F40400681/83: CLEANER ASSY, LH BT 900RPM W/O VSS / W/ VSS, 68D.
 3. * LINE ITEM ON SALES ORDER. NOT INCLUDED IN BILL OF MATERIAL.



CLIPPER
SEPARATION TECHNOLOGIES
SINCE 1889

DIVISION OF
A.T.FERRELL COMPANY
 1440 S ADAMS ST
 BLUFFTON, INDIANA
 46714 - USA
 PH: 260-824-3400
 FAX: 260-824-5483

This drawing is the property of the A.T. Ferrell Company, Inc and must be returned immediately upon request. No part of this drawing may be reproduced, stored in a retrieval system or transmitted in any form or by any means, without prior written consent of the A.T. Ferrell Company, Inc.

TOLERANCES EXCEPT AS NOTED:	TITLE:
DECIMAL: ± .030	SHOE ASSY, LH BOTTOM W/ROCKERS, 68A & D
FRACTIONAL: ± 1/32	
ANGULAR: ± 1/2°	
FINISH: NONE	
SCALE: 0.16:1	
SHEET: 2 OF 2	
SIZE: D	
PART NUMBER: F03008106	
REV: B	