

REVISION HISTORY				
REV	ECN	DESCRIPTION	DATE	APPROVED
A	F100171	REDRAWN IN INVENTOR, UPDATED ASSY	8/4/2010	SH

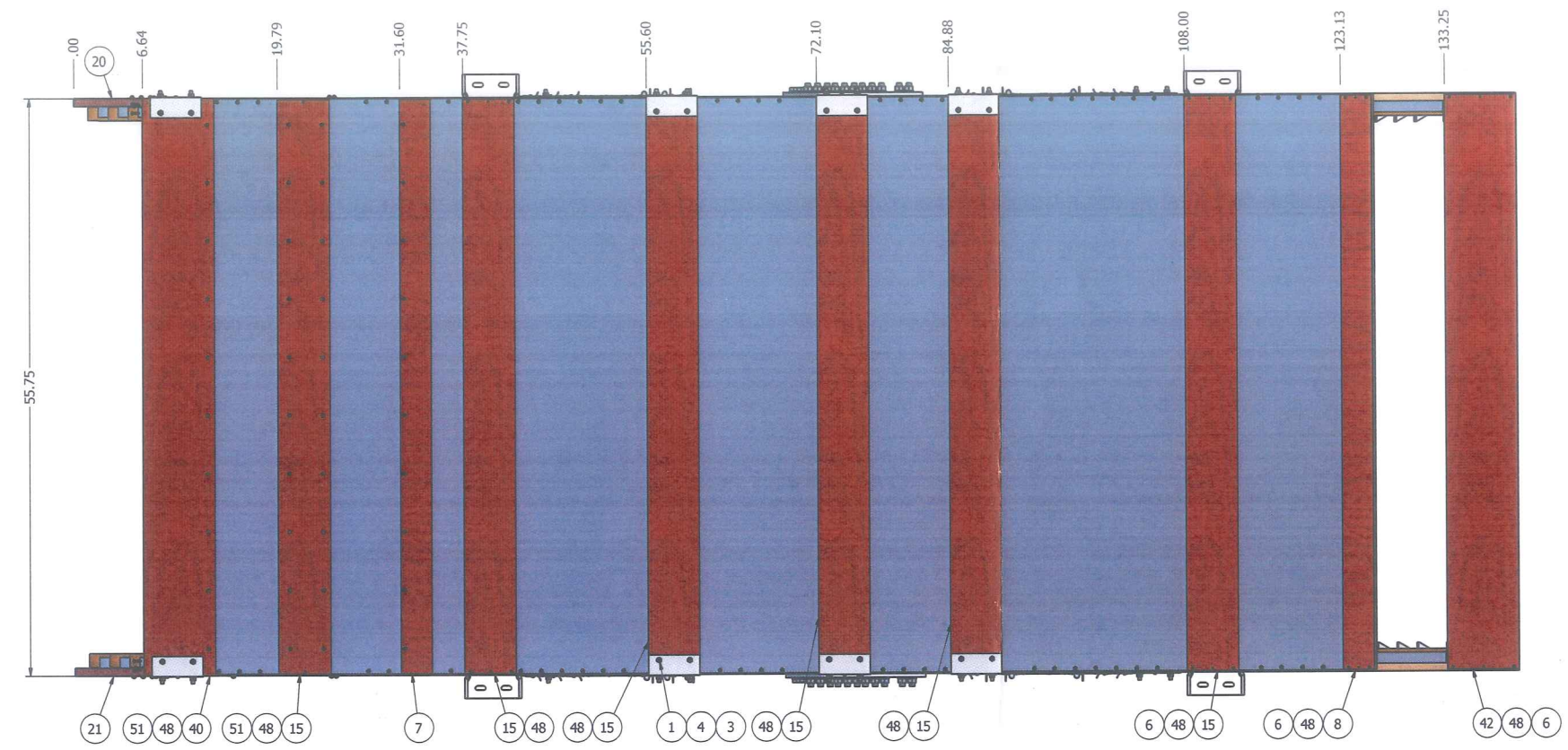

BOTTOM VIEW - BOTTOM BOARD ASSY

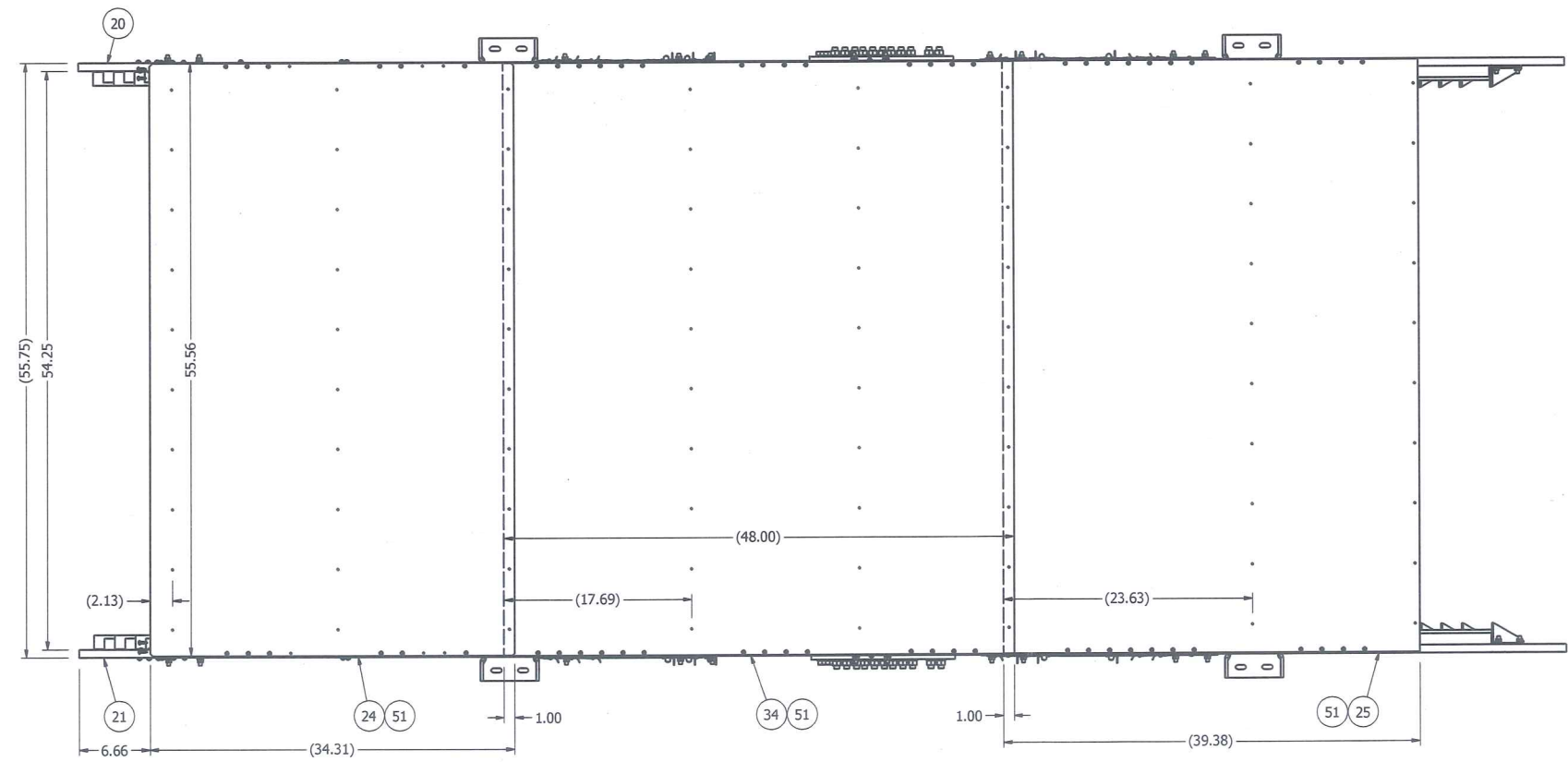

BOTTOM VIEW - BOTTOM METAL ASSY

57	SALES ORDER	16	26" SCREEN W/LIP
56	F98600005	4	LATCH SET, 2PC SCD20649SS-M/SCD2065012ZE
55	F92053390	1	SCREEN BLANK ASSY, 9X54" W/LIP
54	F92053018	1	BLANK ASSY, SCREEN W/LIP 11.00" X #8
53	F91151006	2	BELTING, 1-PLY .06 X 6.00 X 6.88"
52	F90008270	16	BALL TRAY WLDMT, 26.25 X 54.00" NG
51	F83453402	417	SMS, PHP PAN HD #8 X 3/4"
50	F83440135	12	SCW, SMS PAN HD #10 X 1.75"
49	F83200011	74	RIVET, POP SDS64 .188X.125-.250
48	F82400002	20	NAIL, 14 GA X 3/4" THRD, 7/32" HD T304SS
47	F80026101	1280	BALL, RUBBER 1 3/8" BLACK
46	F69681359	1	END, DISCH SPOUT, BTM SHOE II 968
45	F69681358	1	SPOUT, BOTTOM DISCHARGE 768-968
44	F69681356	3	DEFLECTOR II 768-968
43	F69681353	1	SHOE BTM MTL I, BTM SHOE II 968
42	F69681349	1	CROSS BOARD W/.06 X .81 NOTCH, 7" 768-968
41	F69681294	2	EXTENSION, DISCHARGE SPOUT, 968
40	F69681267	1	CROSS BOARD 7" 768-968
39	F69681265	1	SCREEN BLANK 18 X 54 W/LIP
38	F69681264	6	SPOUT, SPLIT DISCHARGE 768-968
37	F69681263	2	END, DISCHARGE SPOUT, 768-968
36	F69681262	2	SPOUT, DISCHARGE 7 DEG, 768-968
35	F69681260	3	DEFLECTOR I 768-968
34	F69681256	1	SHOT BTM MTL II, TOP SHOE 968
33	F67681442	2	BACK PLATE, SIDE SPUT, FNT 768MC
32	F67681441	2	BACK PLATE, SIDE SPUT, FNT 768MC
31	F67681440	2	SPOUT, 768MC REAR SHOE SIDE
30	F67681439	2	SPOUT, 768MC FRONT SHOE SIDE
29	F67681438	2	DIVIDER, CATCHALL 768MC
28	F67681437	2	BACK PLATE, CATCHALL 768MC
27	F67681436	2	CATCHALL, SIDE SPOUT 768MC
26	F67681430	2	SPOUT, SIDE W/DOOR ASSY, BTM SHOE 768MC
25	F67681426	1	SHOE BTM MTL II, BTM SHOE 768MC
24	F67681424	1	SHOE BTM MTL IV, BTM SHOE 768MC
23	F67681408	1	SHOE, BACK SIDE, BOTTOM SHOE ASSY, 768 MC
22	F67681407	1	SHOE, FRONT SIDE, BOTTOM SHOE ASSY, 768 MC
21	F67681406	1	SHOE, RIGHT SIDE, BOTTOM ASSY 768MC
20	F67681405	1	SHOE, LEFT SIDE, BOTTOM ASSY 768MC
19	F62241560	1	SPLTTR ASSY/WLDMT 25/75 #3 #8X9" SC4HC
18	F62241464	1	SUPPORT ANGLE, BTM SHOE, TITAN
17	F62241211	1	SPLITTER WLDMT, 25/75 2ND, #8X9.00" HI-CAP
16	F62241210	1	SPLITTER WLDMT, 25/75 1ST, #8X9.00" HC
15	F61001208	10	BOARD, CROSS 5.00 X 55.75"
14	F61001200	1	PITMAN WLDMT, 55.75"
13	F61001102	3	BOARD, CROSS INTERNAL 2.50 X 54.25"
12	F10808000	12	BLANK ASSY, SCREEN W/LIP 26.25 X 54.00"
11	F10516010	1	BLANK ASSY, SCREEN W/LIP 9.50 X 54"
10	F03805600	2	RUBBER HOLD-DOWN STRIP, 6.75"
9	F03500800	22	SCREEN HOOK ASSY, STANDARD
8	F03108906	1	BOARD, CROSS W/.06 X .81 NOTCH, 3.00 X 55.75"
7	F03108904	1	BOARD, CROSS 3.00 X 55.75" 2248D
6	70010521	43	SCW, DECK FLT HD #6 X 2.00"
5	66445200	12	WASHER, LOCK HELICAL 1/2"
4	66443300	24	WASHER, LOCK HELICAL 1/4"
3	66083300	24	NUT, HEX 1/4-20
2	62585226	12	HHCS, 1/2-13 X 1.25"
1	60283326	24	BOLT, CARR 1/4-20 X 1.25"

This drawing is the property of the A.T. Ferrell Company, Inc. and must be returned immediately upon request. No part of this drawing may be reproduced, stored in a retrieval system or transmitted in any form or by any means, without prior written consent of the A.T. Ferrell Company, Inc.

CAD NO MANUAL CHANGES TOLERANCES EXCEPT AS NOTED		DIVISION OF A. T. FERRELL COMPANY BLUFFTON, INDIANA - USA	
DECIMAL: .005 FRACTIONAL: 1/32 ANGULAR: 1/2°	FINISH: SCALE: 1:8 DATE: 5/21/2009 SIZE: D	DRAWN BY: sahamman APPROVED BY: DJ	TITLE: SHOE ASSY, BOTTOM, 768MC PART NUMBER: F67681401
SHEET: 1 of 8		SHEET: 1 of 8	

NOTES:
1. DO NOT SCALE FROM DRAWING.

REVISION HISTORY				
REV	ECN	DESCRIPTION	DATE	APPROVED
A	F100171	REDRAWN IN INVENTOR, UPDATED ASSY	8/4/2010	SH

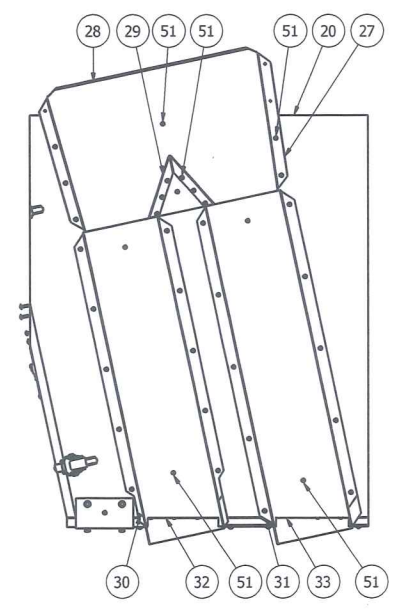
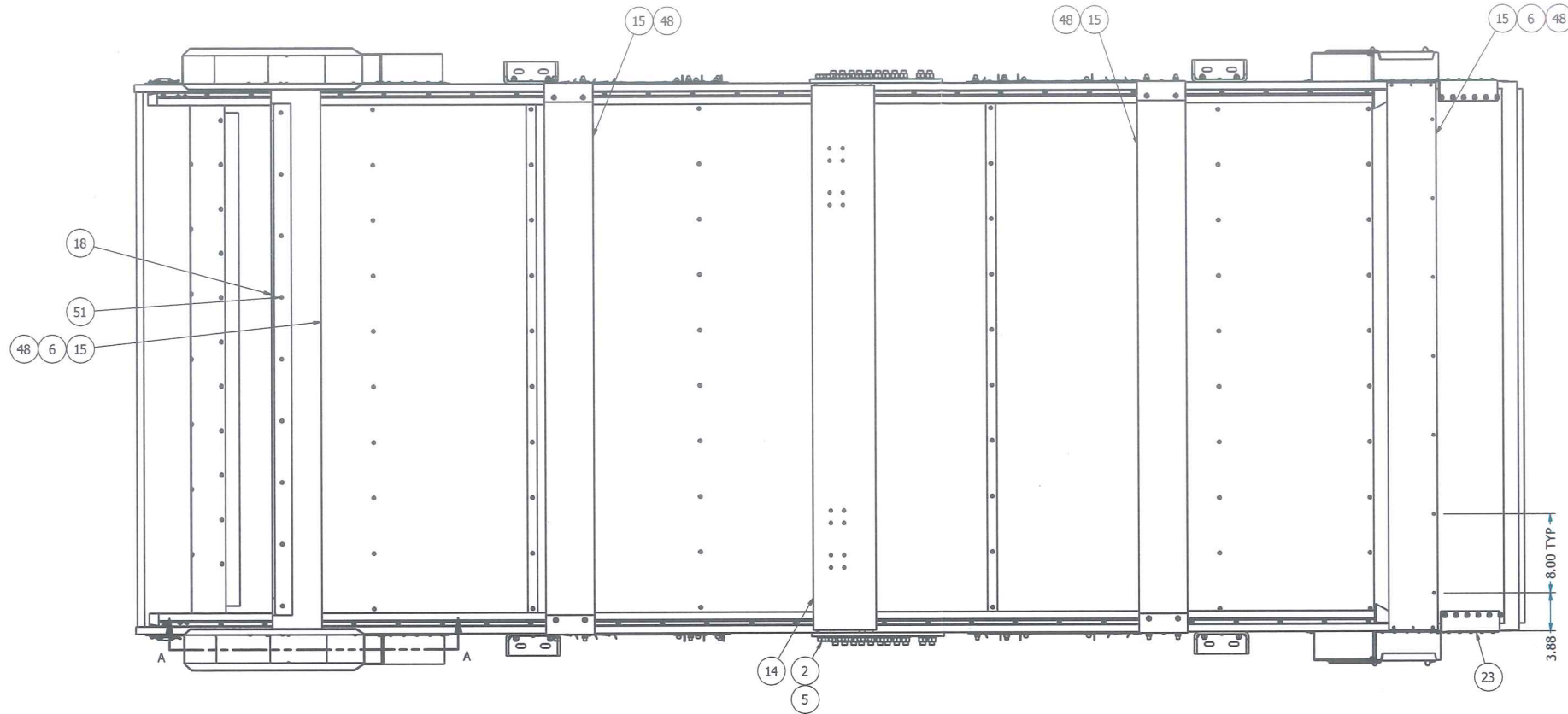

SECTION A-A
SCALE 1/8

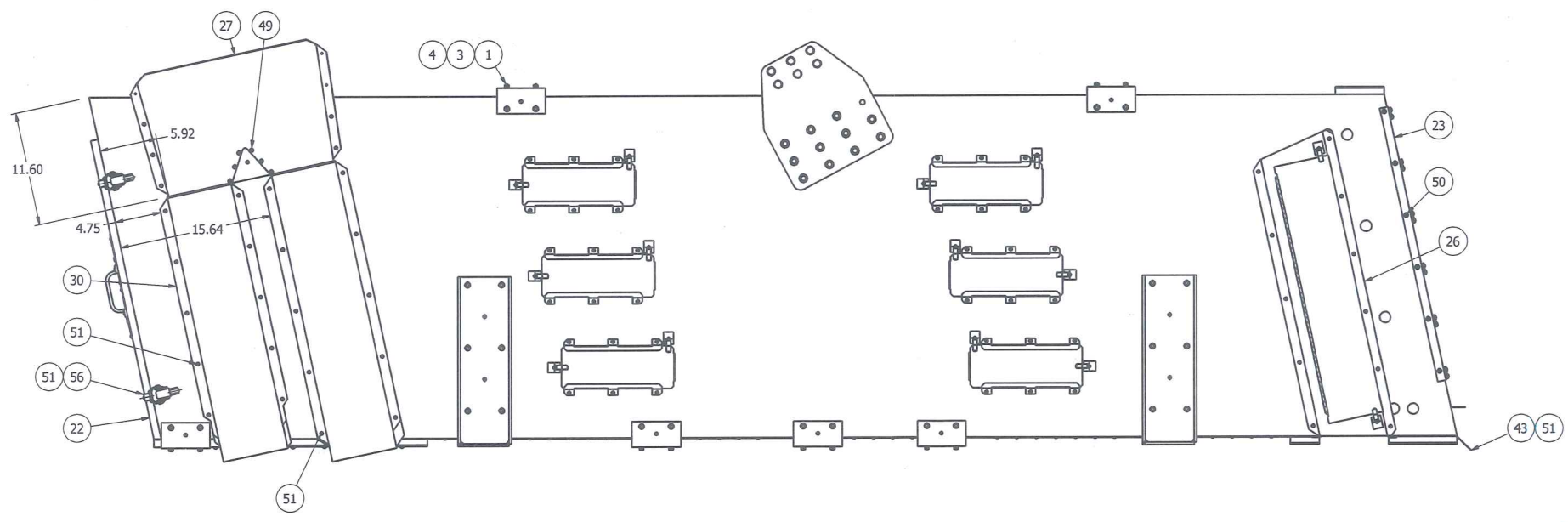

RIGHT SIDE - EXTERNAL ASSY

ITEM	PART NUMBER	QTY	DESCRIPTION
57	SALES ORDER	16	26" SCREEN W/LIP
56	F98600005	4	LATCH SET, 2PC SCD20649SS-M/SCD2065012ZE
55	F92053390	1	SCREEN BLANK ASSY, 9X54" W/LIP
54	F92053018	1	BLANK ASSY, SCREEN W/LIP 11.00" X #8
53	F91151006	2	BELTING, 1-PLY .06 X 6.00 X 6.88"
52	F90008270	16	BALL TRAY WLDMT, 26.25 X 54.00" NG
51	F83453402	417	SMS, PHP PAN HD #8 X 3/4"
50	F83440135	12	SCW, SMS PAN HD #10 X 1.75"
49	F83200011	74	RIVET, POP SDS64 .188X.125-.250
48	F82400002	20	NAIL, 14 GA X 3/4" THRD, 7/32" HD T304SS
47	F80026101	1280	BALL, RUBBER 1 3/8" BLACK
46	F69681359	1	END, DISCH SPOUT, BTM SHOE II 968
45	F69681358	1	SPOUT, BOTTOM DISCHARGE 768-968
44	F69681356	3	DEFLECTOR II 768-968
43	F69681353	1	SHOE BTM MTL I, BTM SHOE II 968
42	F69681349	1	CROSS BOARD W/.06 X .81 NOTCH, 7" 768-968
41	F69681294	2	EXTENSION, DISCHARGE SPOUT, 968
40	F69681267	1	CROSS BOARD 7" 768-968
39	F69681265	1	SCREEN BLANK 18 X 54 W/LIP
38	F69681264	6	SPOUT, SPLIT DISCHARGE 768-968
37	F69681263	2	END, DISCHARGE SPOUT, 768-968
36	F69681262	2	SPOUT, DISCHARGE 7 DEG, 768-968
35	F69681260	3	DEFLECTOR I 768-968
34	F69681256	1	SHOT BTM MTL II, TOP SHOE 968
33	F67681442	2	BACK PLATE, SIDE SPUT, FNT 768MC
32	F67681441	2	BACK PLATE, SIDE SPUT, FNT 768MC
31	F67681440	2	SPOUT, 768MC REAR SHOE SIDE
30	F67681439	2	SPOUT, 768MC FRONT SHOE SIDE
29	F67681438	2	DIVIDER, CATCHALL 768MC
28	F67681437	2	BACK PLATE, CATCHALL 768MC
27	F67681436	2	CATCHALL, SIDE SPOUT 768MC
26	F67681430	2	SPOUT, SIDE W/DOOR ASSY, BTM SHOE 768MC
25	F67681426	1	SHOE BTM MTL II, BTM SHOE 768MC
24	F67681424	1	SHOE BTM MTL IV, BTM SHOE 768MC
23	F67681408	1	SHOE, BACK SIDE, BOTTOM SHOE ASSY, 768 MC
22	F67681407	1	SHOE, FRONT SIDE, BOTTOM SHOE ASSY, 768 MC
21	F67681406	1	SHOE, RIGHT SIDE, BOTTOM ASSY 768MC
20	F67681405	1	SHOE, LEFT SIDE, BOTTOM ASSY 768MC
19	F62241560	1	SPLITTR ASSY/WLDMT 25/75 #3 #8X9" SC4HC
18	F62241464	1	SUPPORT ANGLE, BTM SHOE, TITAN
17	F62241211	1	SPLITTR WLDMT, 25/75 2ND, #8X9.00" HI-CAP
16	F62241210	1	SPLITTR WLDMT, 25/75 1ST, #8X9.00" HC
15	F61001208	10	BOARD, CROSS 5.00 X 55.75"
14	F61001200	1	PITMAN WLDMT, 55.75"
13	F61001102	3	BOARD, CROSS INTERNAL 2.50 X 54.25"
12	F10808000	12	BLANK ASSY, SCREEN W/LIP 26.25 X 54.00"
11	F10516010	1	BLANK ASSY, SCREEN W/LIP 9.50 X 54"
10	F03805600	2	RUBBER HOLD-DOWN STRIP, 6.75"
9	F03500800	22	SCREEN HOOK ASSY, STANDARD
8	F03108906	1	BOARD, CROSS W/.06 X .81 NOTCH, 3.00 X 55.75"
7	F03108904	1	BOARD, CROSS 3.00 X 55.75" 2248D
6	70010521	43	SCW, DECK FLT HD #6 X 2.00"
5	66445200	12	WASHER, LOCK HELICAL 1/2"
4	66443300	24	WASHER, LOCK HELICAL 1/4"
3	66083300	24	NUT, HEX 1/4-20
2	62585226	12	HHCS, 1/2-13 X 1.25"
1	60283326	24	BOLT, CARR 1/4-20 X 1.25"

CAD
NO MANUAL CHANGES
TOLERANCES EXCEPT AS NOTED

Division of A. T. Ferrell Company
Bluffton, Indiana - USA

Scale: 1:8
Drawn by: sahamman
Approved by: DJ

Title: SHOE ASSY, BOTTOM, 768MC
Date: 5/21/2009
Size: D
Part Number: F67681401
Sheet: 2 of 8

NOTES:
1. DO NOT SCALE FROM DRAWING.

REVISION HISTORY				
REV	ECN	DESCRIPTION	DATE	APPROVED
A	F100171	REDRAWN IN INVENTOR, UPDATED ASSY	8/4/2010	SH

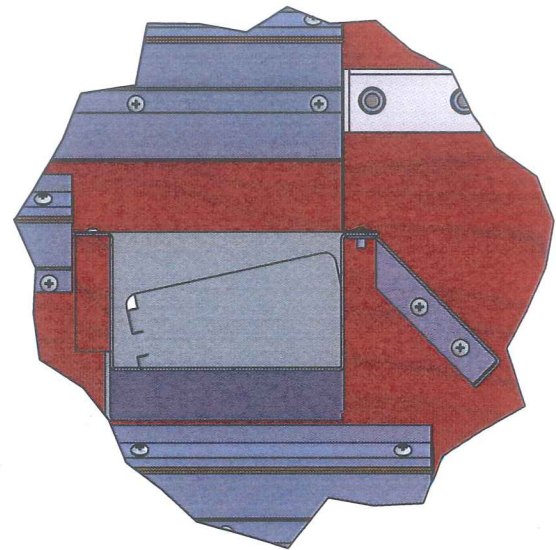
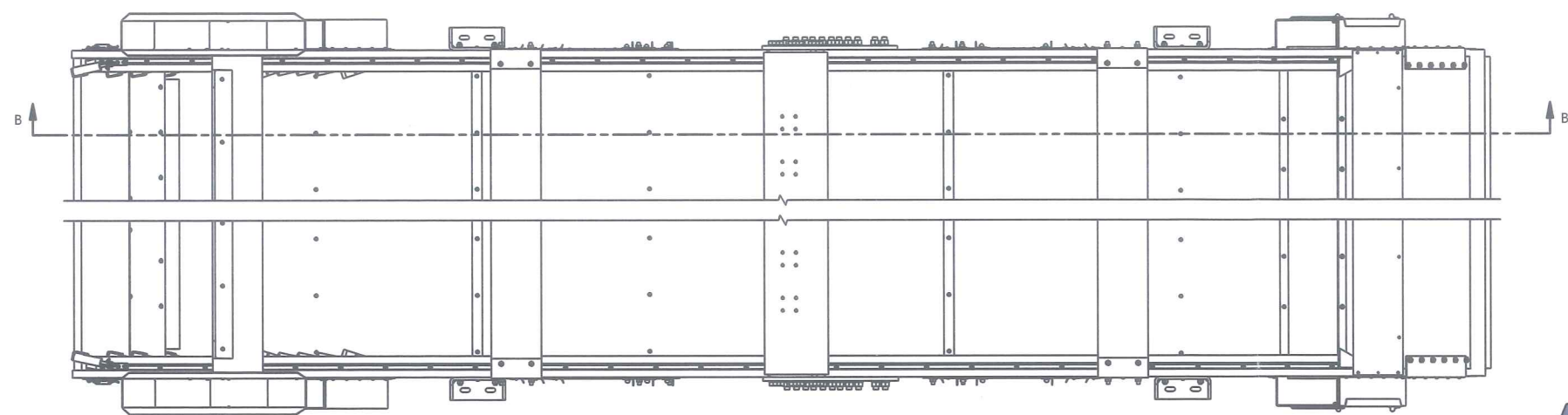

DETAIL B
SCALE .5

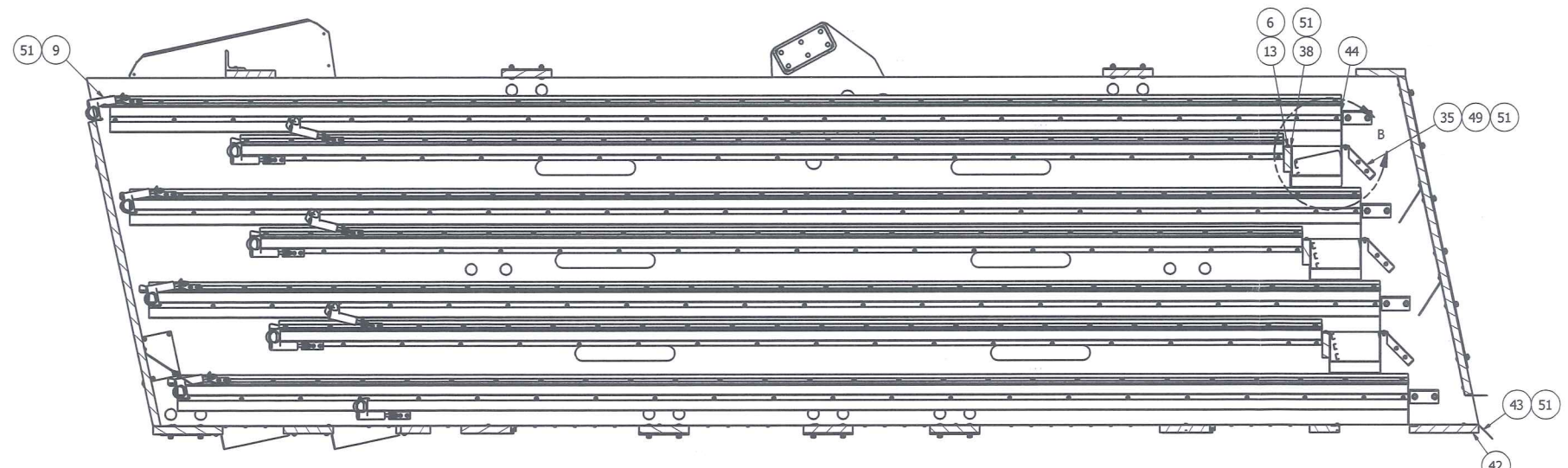

SECTION B-B
SCALE 1/8

57	SALES ORDER	16	26" SCREEN W/LIP
56	F98600005	4	LATCH SET, 2PC SCD20649SS-M/SCD2065012ZE
55	F92053390	1	SCREEN BLANK ASSY, 9X54" W/LIP
54	F92053018	1	BLANK ASSY, SCREEN W/LIP 11.00" X #8
53	F91151006	2	BELTING, 1-PLY .06 X 6.00 X 6.88"
52	F90008270	16	BALL TRAY W/LIP, 26.25 X 54.00" NG
51	F83453402	417	SMS, PHP PAN HD #8 X 3/4"
50	F83440135	12	SCW, SMS PAN HD #10 X 1.75"
49	F83200011	74	RIVET, POP SDS64 .188X.125-.250
48	F82400002	20	NAIL, 14 GA X 3/4" THRD, 7/32" HD T304SS
47	F80026101	1280	BALL, RUBBER 1 3/8" BLACK
46	F69681359	1	END, DISCH SPOUT, BTM SHOE II 968
45	F69681358	1	SPOUT, BOTTOM DISCHARGE 768-968
44	F69681356	3	DEFLECTOR II 768-968
43	F69681353	1	SHOE BTM MTL I, BTM SHOE II 968
42	F69681349	1	CROSS BOARD W/.06 X .81 NOTCH, 7" 768-968
41	F69681294	2	EXTENSION, DISCHARGE SPOUT, 968
40	F69681267	1	CROSS BOARD 7" 768-968
39	F69681265	1	SCREEN BLANK 18 X 54 W/LIP
38	F69681264	6	SPOUT, SPLIT DISCHARGE 768-968
37	F69681263	2	END, DISCHARGE SPOUT, 768-968
36	F69681262	2	SPOUT, DISCHARGE 7 DEG, 768-968
35	F69681260	3	DEFLECTOR I 768-968
34	F69681256	1	SHOT BTM MTL II, TOP SHOE 968
33	F67681442	2	BACK PLATE, SIDE SPUT, FNT 768MC
32	F67681441	2	BACK PLATE, SIDE SPUT, FNT 768MC
31	F67681440	2	SPOUT, 768MC REAR SHOE SIDE
30	F67681439	2	SPOUT, 768MC FRONT SHOE SIDE
29	F67681438	2	DIVIDER, CATCHALL 768MC
28	F67681437	2	BACK PLATE, CATCHALL 768MC
27	F67681436	2	CATCHALL, SIDE SPOUT 768MC
26	F67681430	2	SPOUT, SIDE W/DOOR ASSY, BTM SHOE 768MC
25	F67681426	1	SHOE BTM MTL II, BTM SHOE 768MC
24	F67681424	1	SHOE BTM MTL IV, BTM SHOE 768MC
23	F67681408	1	SHOE, BACK SIDE, BOTTOM SHOE ASSY, 768 MC
22	F67681407	1	SHOE, FRONT SIDE, BOTTOM SHOE ASSY, 768 MC
21	F67681406	1	SHOE, RIGHT SIDE, BOTTOM ASSY 768MC
20	F67681405	1	SHOE, LEFT SIDE, BOTTOM ASSY 768MC
19	F62241560	1	SPLTTR ASSY/WLDMT 25/75 #3 #8X9" SC4HC
18	F62241464	1	SUPPORT ANGLE, BTM SHOE, TITAN
17	F62241211	1	SPLITTER WLDMT, 25/75 2ND, #8X9.00" HI-CAP
16	F62241210	1	SPLITTER WLDMT, 25/75 1ST, #8X9.00" HC
15	F61001208	10	BOARD, CROSS 5.00 X 55.75"
14	F61001200	1	PITMAN WLDMT, 55.75"
13	F61001102	3	BOARD, CROSS INTERNAL 2.50 X 54.25"
12	F10808000	12	BLANK ASSY, SCREEN W/LIP 26.25 X 54.00"
11	F10516010	1	BLANK ASSY, SCREEN W/LIP 9.50 X 54"
10	F03805600	2	RUBBER HOLD-DOWN STRIP, 6.75"
9	F03500800	22	SCREEN HOOK ASSY, STANDARD
8	F03108906	1	BOARD, CROSS W/.06 X .81 NOTCH, 3.00 X 55.75"
7	F03108904	1	BOARD, CROSS 3.00 X 55.75" 2248D
6	70010521	43	SCW, DECK FLT HD #6 X 2.00"
5	66445200	12	WASHER, LOCK HELICAL 1/2"
4	66443300	24	WASHER, LOCK HELICAL 1/4"
3	66083300	24	NUT, HEX 1/4-20
2	62585226	12	HHCS, 1/2-13 X 1.25"
1	60283326	24	BOLT, CARR 1/4-20 X 1.25"

ITEM	PART NUMBER	QTY	DESCRIPTION
Parts List			
This drawing is the property of the A.T. Ferrell Company, Inc. and must be returned immediately upon request. No part of this drawing may be reproduced, stored in a retrieval system or transmitted in any form or by any means, without prior written consent of the A.T. Ferrell Company, Inc.			
CAD NO MANUAL CHANGES TOLERANCES EXCEPT AS NOTED		DIVISION OF A. T. FERRELL COMPANY BLUFFTON, INDIANA - USA	
DECIMAL: XXX ± .005 XX ± .030	FINISH: SCALE: 1:8	DRAWN BY: SAHMAN	APPROVED BY: DJ
FRACTIONAL: = 1/32	TITLE: SHOE ASSY, BOTTOM, 768MC		
ANGULAR: ± 1/2°	DATE: 5/21/2009	SIZE: D	PART NUMBER: F67681401
			SHEET: 3 of 8

NOTES:
1. DO NOT SCALE FROM DRAWING.

F67681401

A

REVISION HISTORY				
REV	ECN	DESCRIPTION	DATE	APPROVED
A	F100171	REDRAWN IN INVENTOR, UPDATED ASSY	8/4/2010	SH

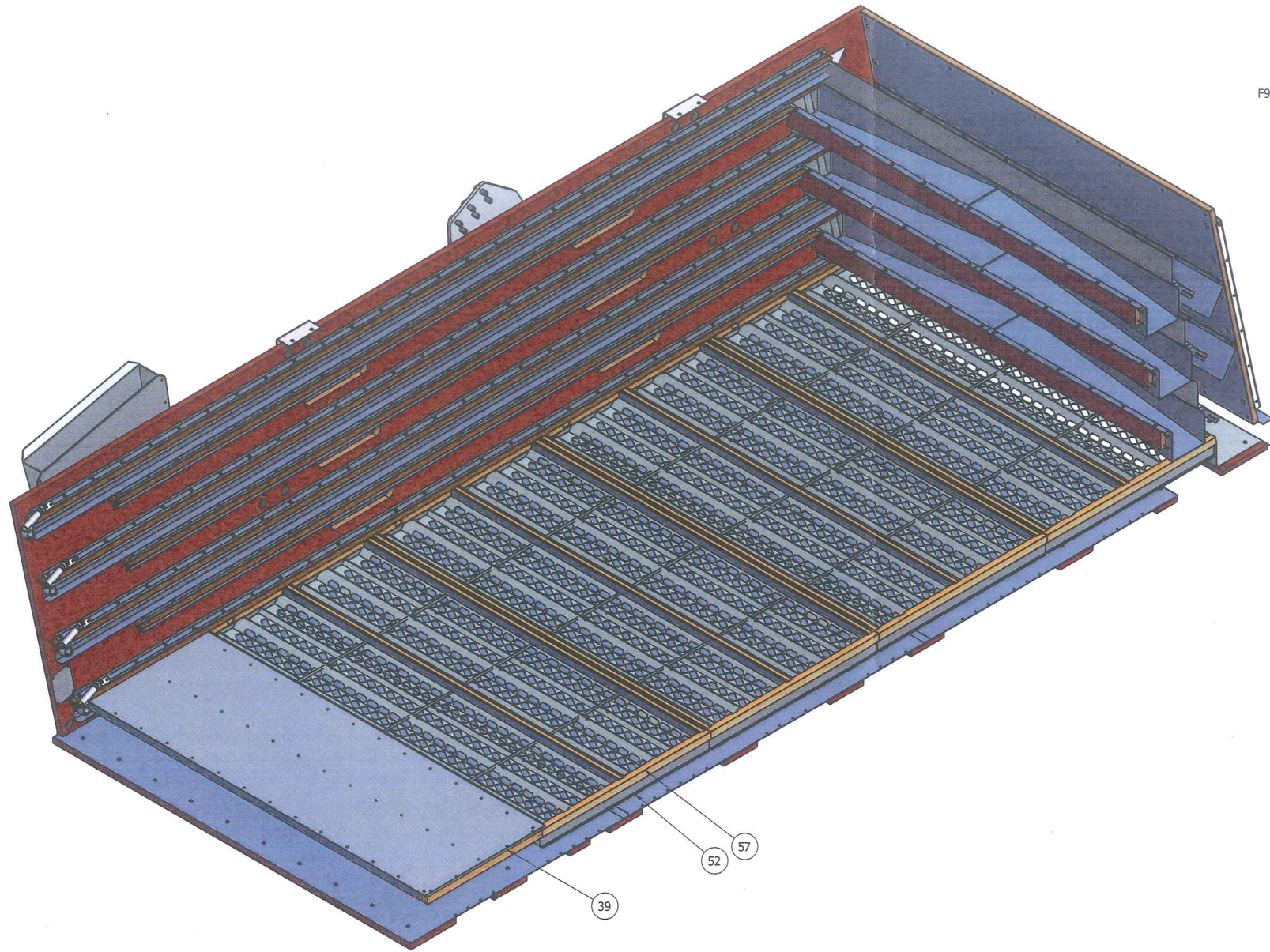

SCREEN & BALL TRAY INSTALL
4TH RAIL SHOWN

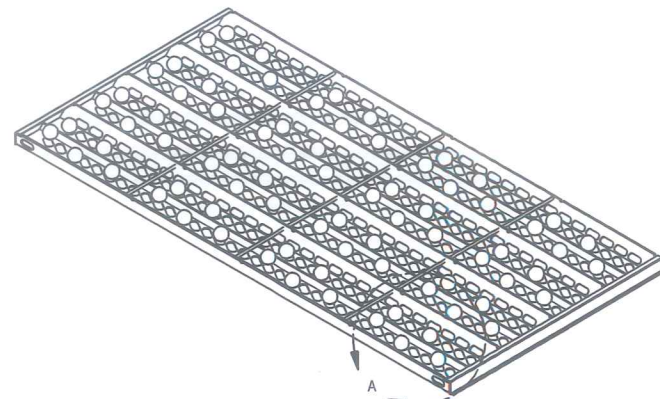

F90008270 W / BALLS (F80026101)
SCALE 1/8

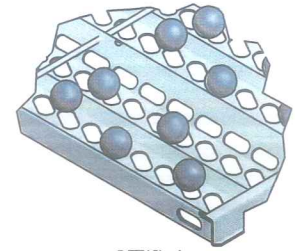

DETAIL A
SCALE 1 / 4
5 BALLS (F80026101) PER COMPARTMENT
80 BALLS PER TRAY

57	SALES ORDER	16	26" SCREEN W/LIP
56	F98600005	4	LATCH SET, 2PC SCD206495S-M/SCD2065012ZE
55	F92053390	1	SCREEN BLANK ASSY, 9X54" W/LIP
54	F92053018	1	BLANK ASSY, SCREEN W/LIP 11.00" X #8
53	F91151006	2	BELTING, 1-PLY .06 X 6.00 X 6.88"
52	F90008270	16	BALL TRAY W/LIP, 26.25 X 54.00" NG
51	F83453402	417	SMS, PHP PAN HD #8 X 3/4"
50	F83440135	12	SCW, SMS PAN HD #10 X 1.75"
49	F83200011	74	RIVET, POP SDS64 .188X.125-.250
48	F82400002	20	NAIL, 14 GA X 3/4" THRD, 7/32" HD T304SS
47	F80026101	1280	BALL, RUBBER 1 3/8" BLACK
46	F69681359	1	END, DISCH SPOUT, BTM SHOE II 968
45	F69681358	1	SPOUT, BOTTOM DISCHARGE 768-968
44	F69681356	3	DEFLECTOR II 768-968
43	F69681353	1	SHOE BTM MTL I, BTM SHOE II 968
42	F69681349	1	CROSS BOARD W/.06 X .81 NOTCH, 7" 768-968
41	F69681294	2	EXTENSION, DISCHARGE SPOUT, 968
40	F69681267	1	CROSS BOARD 7" 768-968
39	F69681265	1	SCREEN BLANK 18 X 54 W/LIP
38	F69681264	6	SPOUT, SPLIT DISCHARGE 768-968
37	F69681263	2	END, DISCHARGE SPOUT, 768-968
36	F69681262	2	SPOUT, DISCHARGE 7 DEG, 768-968
35	F69681260	3	DEFLECTOR I 768-968
34	F69681256	1	SHOT BTM MTL II, TOP SHOE 968
33	F67681442	2	BACK PLATE, SIDE SPUT, FNT 768MC
32	F67681441	2	BACK PLATE, SIDE SPUT, FNT 768MC
31	F67681440	2	SPOUT, 768MC REAR SHOE SIDE
30	F67681439	2	SPOUT, 768MC FRONT SHOE SIDE
29	F67681438	2	DIVIDER, CATCHALL 768MC
28	F67681437	2	BACK PLATE, CATCHALL 768MC
27	F67681436	2	CATCHALL, SIDE SPOUT 768MC
26	F67681430	2	SPOUT, SIDE W/DOOR ASSY, BTM SHOE 768MC
25	F67681426	1	SHOE BTM MTL II, BTM SHOE 768MC
24	F67681424	1	SHOE BTM MTL IV, BTM SHOE 768MC
23	F67681408	1	SHOE, BACK SIDE, BOTTOM SHOE ASSY, 768 MC
22	F67681407	1	SHOE, FRONT SIDE, BOTTOM SHOE ASSY, 768 MC
21	F67681406	1	SHOE, RIGHT SIDE, BOTTOM ASSY 768MC
20	F67681405	1	SHOE, LEFT SIDE, BOTTOM ASSY 768MC
19	F62241560	1	SPLTR ASSY/WLDMT 25/75 #3 #8X9" SC4HC
18	F62241464	1	SUPPORT ANGLE, BTM SHOE, TITAN
17	F62241211	1	SPLITTER WLDMT, 25/75 2ND, #8X9.00" HI-CAP
16	F62241210	1	SPLITTER WLDMT, 25/75 1ST, #8X9.00" HC
15	F61001208	10	BOARD, CROSS 5.00 X 55.75"
14	F61001200	1	PITMAN WLDMT, 55.75"
13	F61001102	3	BOARD, CROSS INTERNAL 2.50 X 54.25"
12	F10808000	12	BLANK ASSY, SCREEN W/LIP 26.25 X 54.00"
11	F10516010	1	BLANK ASSY, SCREEN W/LIP 9.50 X 54"
10	F03805600	2	RUBBER HOLD-DOWN STRIP, 6.75"
9	F03500800	22	SCREEN HOOK ASSY, STANDARD
8	F03108906	1	BOARD, CROSS W/.06 X .81 NOTCH, 3.00 X 55.75"
7	F03108904	1	BOARD, CROSS 3.00 X 55.75" 2248D
6	70010521	43	SCW, DECK FLT HD #6 X 2.00"
5	66445200	12	WASHER, LOCK HELICAL 1/2"
4	66443300	24	WASHER, LOCK HELICAL 1/4"
3	66083300	24	NUT, HEX 1/4-20
2	62585226	12	HHCS, 1/2-13 X 1.25"
1	60283326	24	BOLT, CARR 1/4-20 X 1.25"

ITEM	PART NUMBER	QTY	DESCRIPTION
Parts List			

This drawing is the property of the A.T. Ferrell Company, Inc and must be returned immediately upon request. No part of this drawing may be reproduced, stored in a retrieval system or transmitted in any form or by any means, without prior written consent of the A.T. Ferrell Company, Inc

CAD
NO MANUAL CHANGES
EXCEPT AS NOTED

TOLERANCES EXCEPT AS NOTED

DECIMAL: .005
FRACTIONAL: 1/32
ANGULAR: 1/2

DIVISION OF A. T. FERRELL COMPANY
FINISH: 1:8
SCALE: 1:8
DRAWN BY: sahamman
APPROVED BY: DJ

TITLE: SHOE ASSY, BOTTOM, 768MC
DATE: 5/21/2009
SIZE: D
PART NUMBER: F67681401
SHEET: 4 of 8



NOTES:
1. DO NOT SCALE FROM DRAWING.

REVISION HISTORY				
REV	ECN	DESCRIPTION	DATE	APPROVED
A	F100171	REDRAWN IN INVENTOR, UPDATED ASSY	8/4/2010	SH

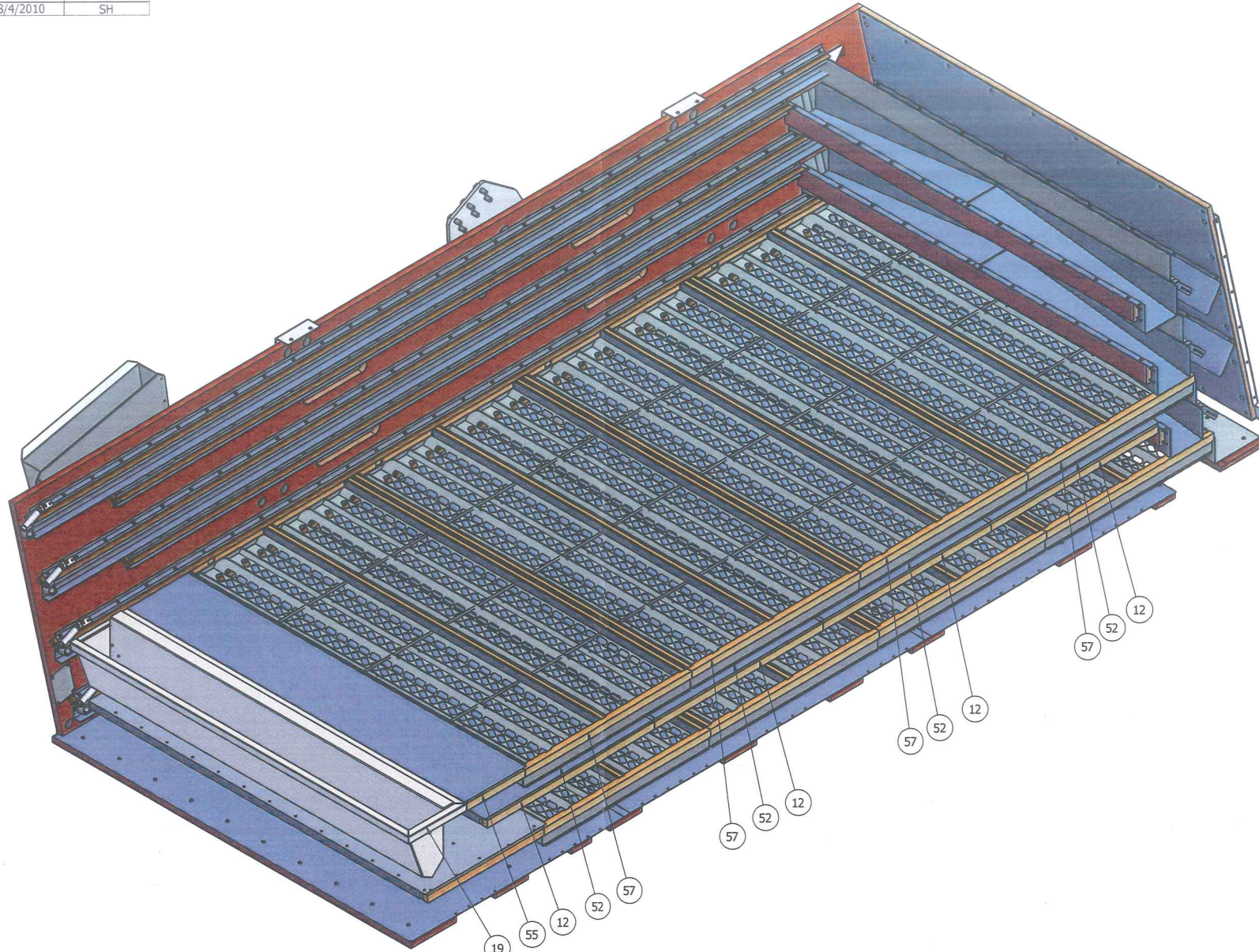

SCREEN, BALL & BLANK RAIL INSTALL
3RD RAIL SHOWN

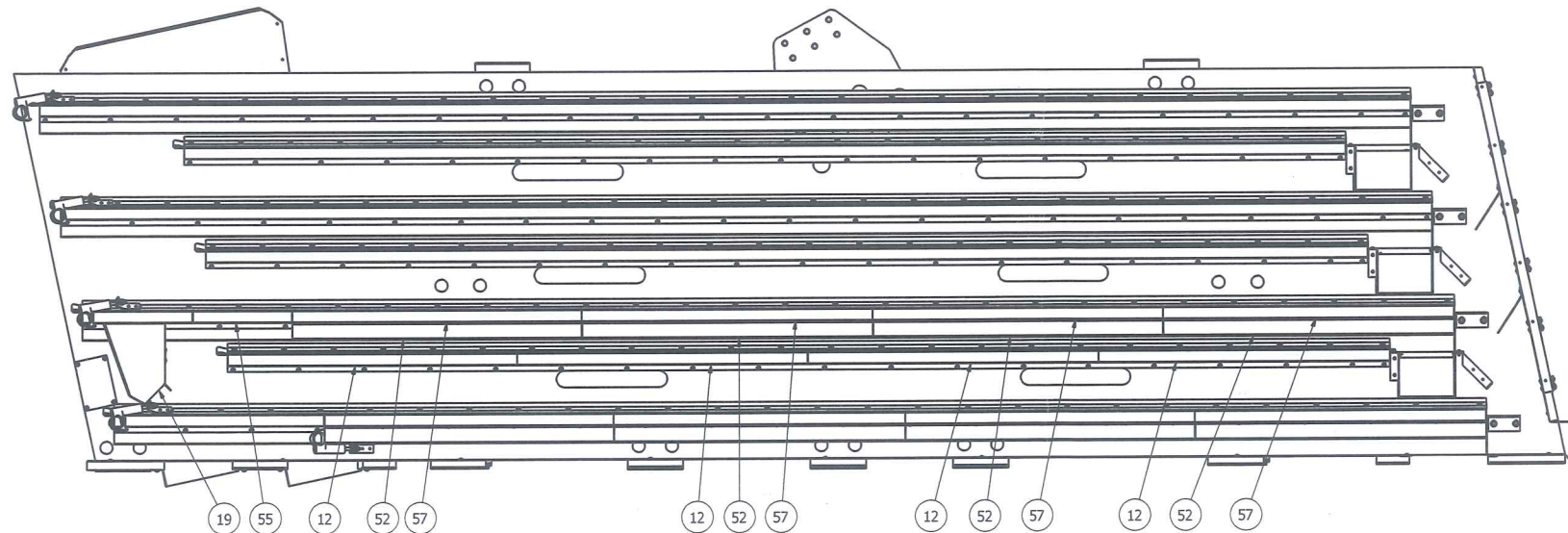

ITEM	PART NUMBER	QTY	DESCRIPTION
57	SALES ORDER	16	26" SCREEN W/LIP
56	F98600005	4	LATCH SET, 2PC SCD20649SS-M/SCD2065012ZE
55	F92053390	1	SCREEN BLANK ASSY, 9X54" W/LIP
54	F92053018	1	BLANK ASSY, SCREEN W/LIP 11.00" X #8
53	F91151006	2	BELTING, 1-PLY .06 X 6.00 X 6.88"
52	F90008270	16	BALL TRAY W/LDMT, 26.25 X 54.00" NG
51	F83453402	417	SMS, PHP PAN HD #8 X 3/4"
50	F83440135	12	SCW, SMS PAN HD #10 X 1.75"
49	F83200011	74	RIVET, POP SDS64 .188X.125-.250
48	F82400002	20	NAIL, 14 GA X 3/4" THRD, 7/32" HD T304SS
47	F80026101	1280	BALL, RUBBER 1 3/8" BLACK
46	F69681359	1	END, DISCH SPOUT, BTM SHOE II 968
45	F69681358	1	SPOUT, BOTTOM DISCHARGE 768-968
44	F69681356	3	DEFLECTOR II 768-968
43	F69681353	1	SHOE BTM MTL I, BTM SHOE II 968
42	F69681349	1	CROSS BOARD W/.06 X .81 NOTCH, 7" 768-968
41	F69681294	2	EXTENSION, DISCHARGE SPOUT, 968
40	F69681267	1	CROSS BOARD 7" 768-968
39	F69681265	1	SCREEN BLANK 18 X 54 W/LIP
38	F69681264	6	SPOUT, SPLIT DISCHARGE 768-968
37	F69681263	2	END, DISCHARGE SPOUT, 768-968
36	F69681262	2	SPOUT, DISCHARGE 7 DEG, 768-968
35	F69681260	3	DEFLECTOR I 768-968
34	F69681256	1	SHOT BTM MTL II, TOP SHOE 968
33	F67681442	2	BACK PLATE, SIDE SPUT, FNT 768MC
32	F67681441	2	BACK PLATE, SIDE SPUT, FNT 768MC
31	F67681440	2	SPOUT, 768MC REAR SHOE SIDE
30	F67681439	2	SPOUT, 768MC FRONT SHOE SIDE
29	F67681438	2	DIVIDER, CATCHALL 768MC
28	F67681437	2	BACK PLATE, CATCHALL 768MC
27	F67681436	2	CATCHALL, SIDE SPOUT 768MC
26	F67681430	2	SPOUT, SIDE W/DOOR ASSY, BTM SHOE 768MC
25	F67681426	1	SHOE BTM MTL II, BTM SHOE 768MC
24	F67681424	1	SHOE BTM MTL IV, BTM SHOE 768MC
23	F67681408	1	SHOE, BACK SIDE, BOTTOM SHOE ASSY, 768 MC
22	F67681407	1	SHOE, FRONT SIDE, BOTTOM SHOE ASSY, 768 MC
21	F67681406	1	SHOE, RIGHT SIDE, BOTTOM ASSY 768MC
20	F67681405	1	SHOE, LEFT SIDE, BOTTOM ASSY 768MC
19	F62241560	1	SPLTTR ASSY/WLDMT 25/75 #3 #8X9" SC4HC
18	F62241464	1	SUPPORT ANGLE, BTM SHOE, TITAN
17	F62241211	1	SPLITTER WLDMT, 25/75 2ND, #8X9.00" HI-CAP
16	F62241210	1	SPLITTER WLDMT, 25/75 1ST, #8X9.00" HC
15	F61001208	10	BOARD, CROSS 5.00 X 55.75"
14	F61001200	1	PITMAN WLDMT, 55.75"
13	F61001102	3	BOARD, CROSS INTERNAL 2.50 X 54.25"
12	F10808000	12	BLANK ASSY, SCREEN W/LIP 26.25 X 54.00"
11	F10516010	1	BLANK ASSY, SCREEN W/LIP 9.50 X 54"
10	F03805600	2	RUBBER HOLD-DOWN STRIP, 6.75"
9	F03500800	22	SCREEN HOOK ASSY, STANDARD
8	F03108906	1	BOARD, CROSS W/.06 X .81 NOTCH, 3.00 X 55.75"
7	F03108904	1	BOARD, CROSS 3.00 X 55.75" 2248D
6	70010521	43	SCW, DECK FLT HD #6 X 2.00"
5	66445200	12	WASHER, LOCK HELICAL 1/2"
4	66443300	24	WASHER, LOCK HELICAL 1/4"
3	66083300	24	NUT, HEX 1/4-20
2	62585226	12	HHCS, 1/2-13 X 1.25"
1	60283326	24	BOLT, CARR 1/4-20 X 1.25"

This drawing is the property of the A.T. Ferrell Company, Inc and must be returned immediately upon request. No part of this drawing may be reproduced, stored in retrieval system or transmitted in any form or by any means, without prior written consent of the A.T. Ferrell Company, Inc

CAD NO MANUAL CHANGES TOLERANCES EXCEPT AS NOTED DECIMAL: .005 FRACTIONAL: 1/32 ANGULAR: 1/2°	DIVISION OF A. T. FERRELL COMPANY BLUFFTON, INDIANA, USA	SCALE: 1:8	DRAWN BY: sahamman	APPROVED BY: DJ
		TITLE: SHOE ASSY, BOTTOM, 768MC DATE: 5/21/2009 SIZE: D PART NUMBER: F67681401 SHEET: 5 of 8		

NOTES:
1. DO NOT SCALE FROM DRAWING.

REV	ECN	DESCRIPTION	DATE	APPROVED
A	F100171	REDRAWN IN INVENTOR, UPDATED ASSY	8/4/2010	SH

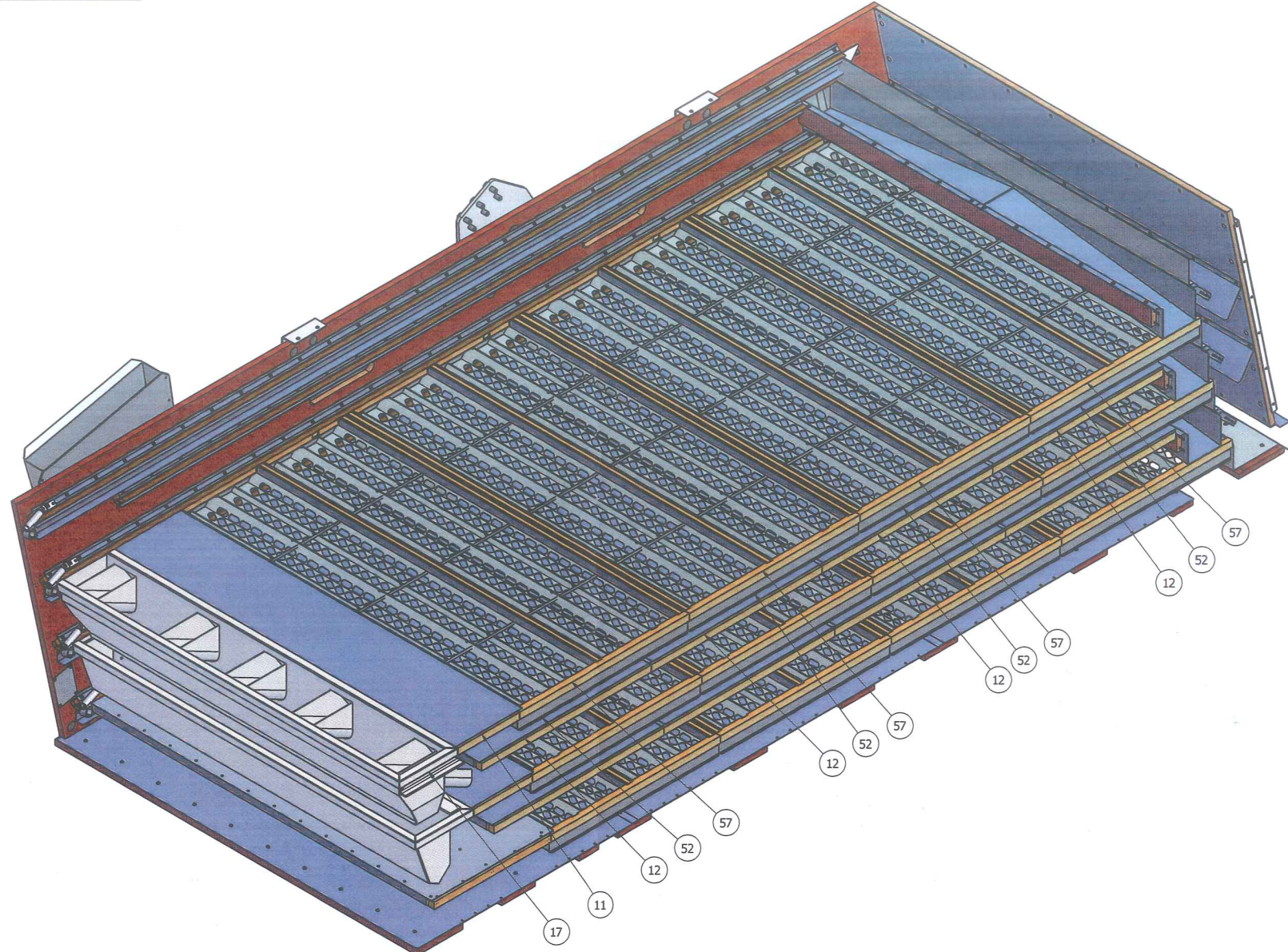

SCREEN, BALL & BLANK RAIL INSTALL
2ND RAIL SHOWN

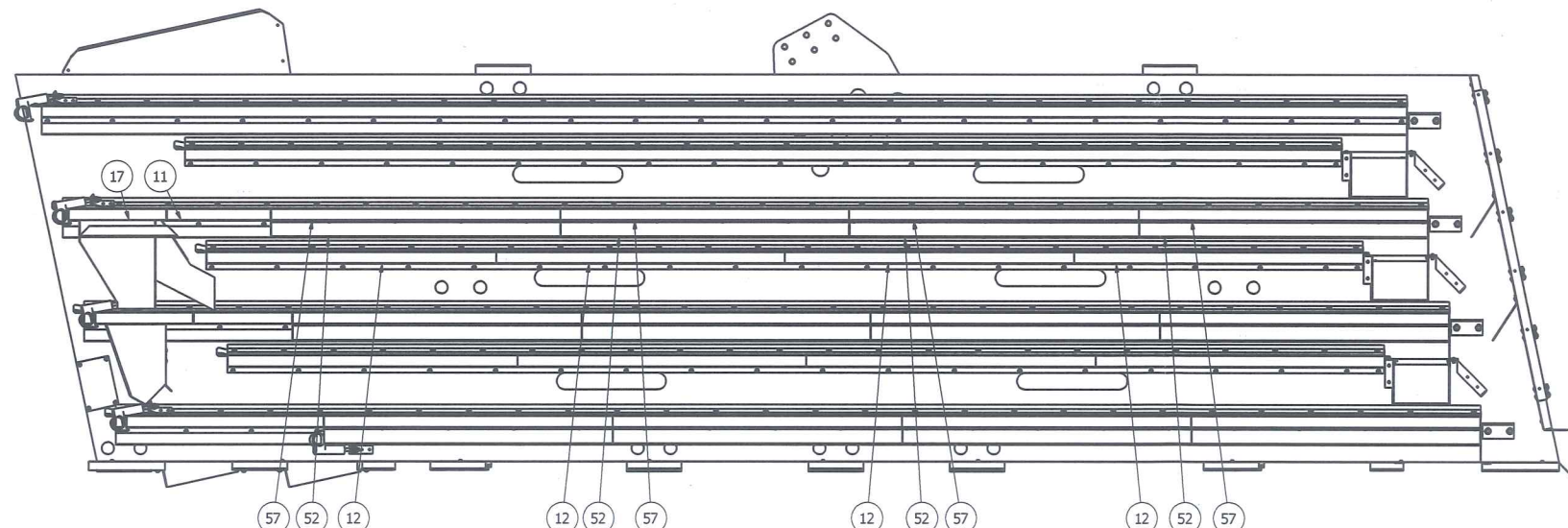

NOTES:
1. DO NOT SCALE FROM DRAWING.

57	SALES ORDER	16	26" SCREEN W/LIP
56	F98600005	4	LATCH SET, 2PC SCD20649SS-M/SCD2065012ZE
55	F92053390	1	SCREEN BLANK ASSY, 9X54" W/LIP
54	F92053018	1	BLANK ASSY, SCREEN W/LIP 11.00" X #8
53	F91151006	2	BELTING, 1-PLY .06 X 6.00 X 6.88"
52	F90008270	16	BALL TRAY WLDMT, 26.25 X 54.00" NG
51	F83453402	417	SMS, PHP PAN HD #8 X 3/4"
50	F83440135	12	SCW, SMS PAN HD #10 X 1.75"
49	F83200011	74	RIVET, POP SDS64 .188X.125-.250
48	F82400002	20	NAIL, 14 GA X 3/4" THRD, 7/32" HD T304SS
47	F80026101	1280	BALL, RUBBER 1 3/8" BLACK
46	F69681359	1	END, DISCH SPOUT, BTM SHOE II 968
45	F69681358	1	SPOUT, BOTTOM DISCHARGE 768-968
44	F69681356	3	DEFLECTOR II 768-968
43	F69681353	1	SHOE BTM MTL I, BTM SHOE II 968
42	F69681349	1	CROSS BOARD W/.06 X .81 NOTCH, 7" 768-968
41	F69681294	2	EXTENSION, DISCHARGE SPOUT, 968
40	F69681267	1	CROSS BOARD 7" 768-968
39	F69681265	1	SCREEN BLANK 18 X 54 W/LIP
38	F69681264	6	SPOUT, SPLIT DISCHARGE 768-968
37	F69681263	2	END, DISCHARGE SPOUT, 768-968
36	F69681262	2	SPOUT, DISCHARGE 7 DEG, 768-968
35	F69681260	3	DEFLECTOR I 768-968
34	F69681256	1	SHOT BTM MTL II, TOP SHOE 968
33	F67681442	2	BACK PLATE, SIDE SPUT, FNT 768MC
32	F67681441	2	BACK PLATE, SIDE SPUT, FNT 768MC
31	F67681440	2	SPOUT, 768MC REAR SHOE SIDE
30	F67681439	2	SPOUT, 768MC FRONT SHOE SIDE
29	F67681438	2	DIVIDER, CATCHALL 768MC
28	F67681437	2	BACK PLATE, CATCHALL 768MC
27	F67681436	2	CATCHALL, SIDE SPOUT 768MC
26	F67681430	2	SPOUT, SIDE W/DOOR ASSY, BTM SHOE 768MC
25	F67681426	1	SHOE BTM MTL II, BTM SHOE 768MC
24	F67681424	1	SHOE BTM MTL IV, BTM SHOE 768MC
23	F67681408	1	SHOE, BACK SIDE, BOTTOM SHOE ASSY, 768 MC
22	F67681407	1	SHOE, FRONT SIDE, BOTTOM SHOE ASSY, 768 MC
21	F67681406	1	SHOE, RIGHT SIDE, BOTTOM ASSY 768MC
20	F67681405	1	SHOE, LEFT SIDE, BOTTOM ASSY 768MC
19	F62241560	1	SPLTTR ASSY/WLDMT 25/75 #3 #8X9" SC4HC
18	F62241464	1	SUPPORT ANGLE, BTM SHOE, TITAN
17	F62241211	1	SPLITTER WLDMT, 25/75 2ND, #8X9.00" HI-CAP
16	F62241210	1	SPLITTER WLDMT, 25/75 1ST, #8X9.00" HC
15	F61001208	10	BOARD, CROSS 5.00 X 55.75"
14	F61001200	1	PITMAN WLDMT, 55.75"
13	F61001102	3	BOARD, CROSS INTERNAL 2.50 X 54.25"
12	F10808000	12	BLANK ASSY, SCREEN W/LIP 26.25 X 54.00"
11	F10516010	1	BLANK ASSY, SCREEN W/LIP 9.50 X 54"
10	F03805600	2	RUBBER HOLD-DOWN STRIP, 6.75"
9	F03500800	22	SCREEN HOOK ASSY, STANDARD
8	F03108906	1	BOARD, CROSS W/.06 X .81 NOTCH, 3.00 X 55.75"
7	F03108904	1	BOARD, CROSS 3.00 X 55.75" 2248D
6	70010521	43	SCW, DECK FLT HD #6 X 2.00"
5	66445200	12	WASHER, LOCK HELICAL 1/2"
4	66443300	24	WASHER, LOCK HELICAL 1/4"
3	66083300	24	NUT, HEX 1/4-20
2	62585226	12	HHCS, 1/2-13 X 1.25"
1	60283326	24	BOLT, CARR 1/4-20 X 1.25"

ITEM	PART NUMBER	QTY	DESCRIPTION
Parts List			

This drawing is the property of the A.T. Ferrell Company, Inc and must be returned immediately upon request. No part of this drawing may be reproduced, stored in a retrieval system or transmitted in any form or by any means without prior written consent of the A.T. Ferrell Company, Inc

CAD
NO MANUAL CHANGES
TOLERANCES EXCEPT AS NOTED

BLUFFTON, INDIANA - USA

DECIMAL: .005	FINISH: DIVISION OF A. T. FERRELL COMPANY	SCALE: 1:8	DRAWN BY: sahamman	APPROVED BY: DJ
FRACTIONAL: 1/32	TITLE: SHOE ASSY, BOTTOM, 768MC			
ANGULAR: 1/2	DATE: 5/21/2009	SIZE: D	PART NUMBER: F67681401	SHEET: 6 of 8

REVISION HISTORY			
REV	ECN	DESCRIPTION	DATE
A	F100171	REDRAWN IN INVENTOR, UPDATED ASSY	8/4/2010

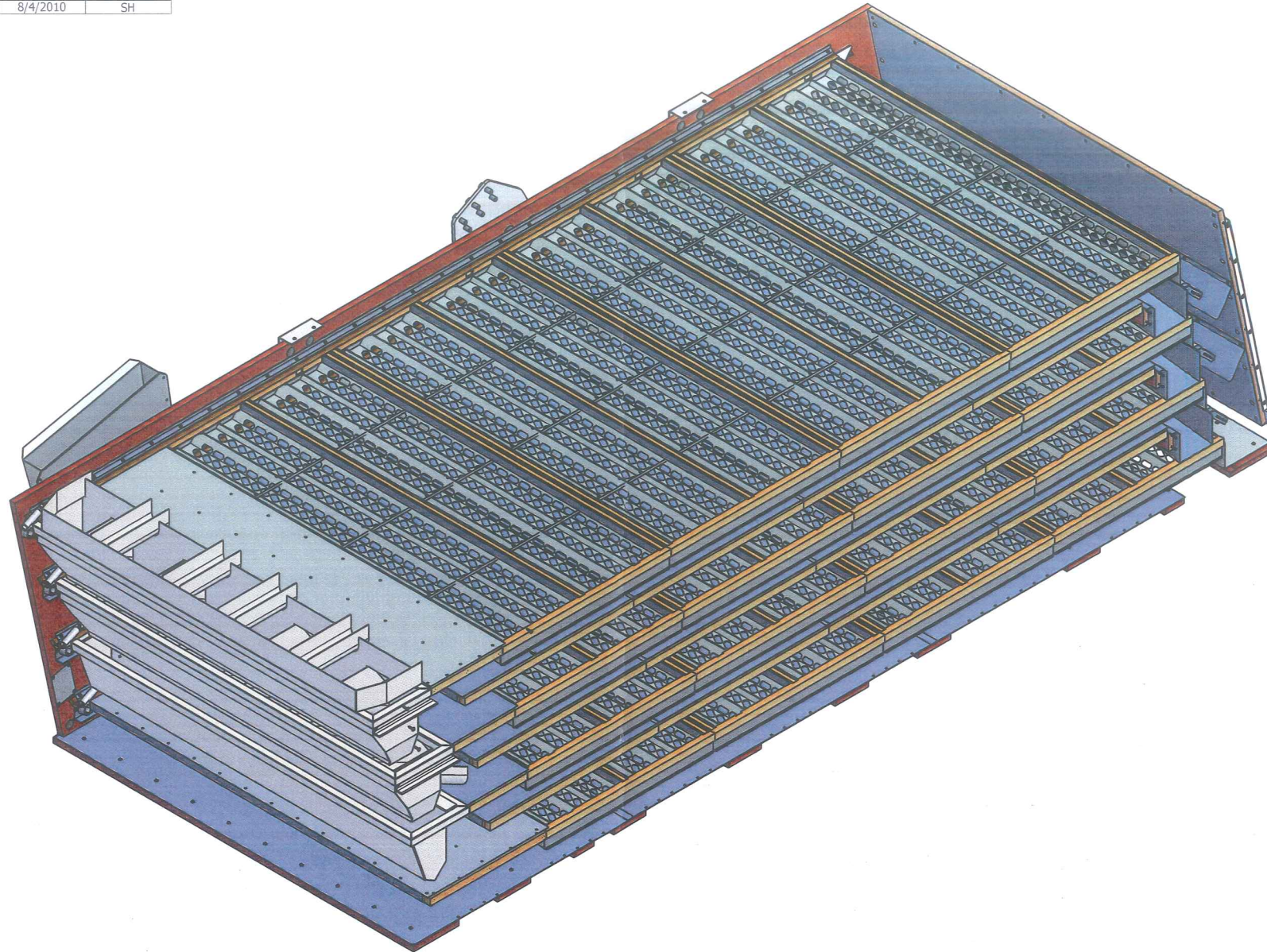

SCREEN, BALL & BLANK RAIL INSTALL
 1ST RAIL SHOWN

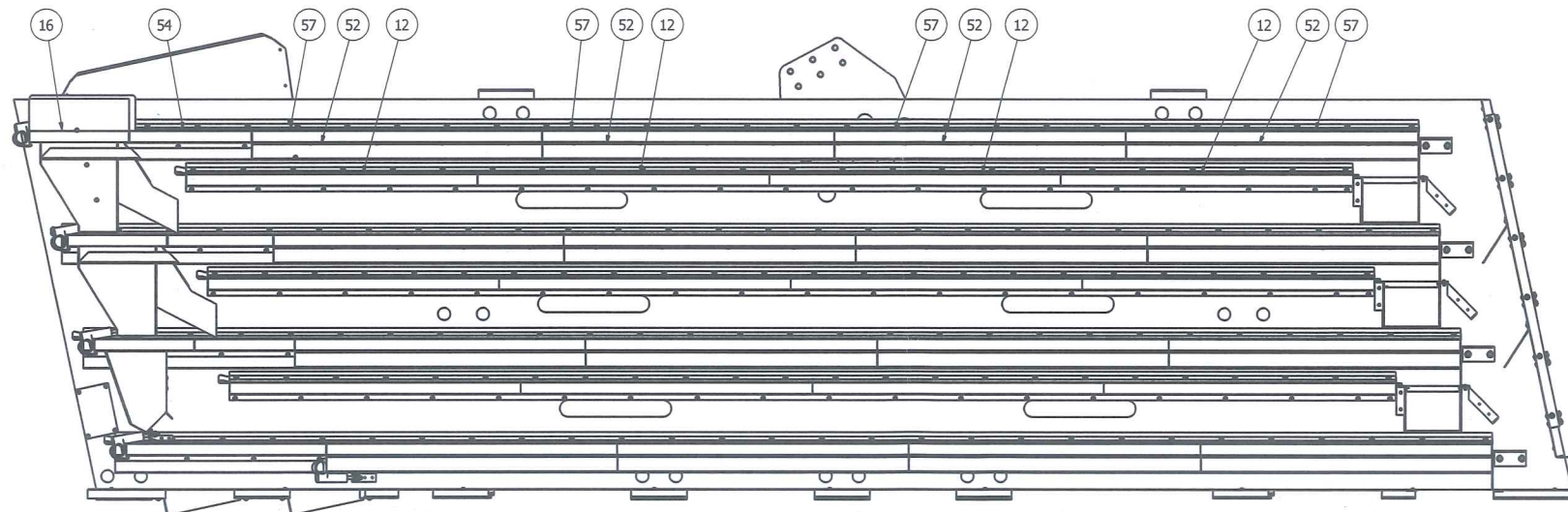

NOTES:
 1. DO NOT SCALE FROM DRAWING.

57	SALES ORDER	16	26" SCREEN W/LIP
56	F98600005	4	LATCH SET, 2PC SCD20649SS-M/SCD2065012ZE
55	F92053390	1	SCREEN BLANK ASSY, 9X54" W/LIP
54	F92053018	1	BLANK ASSY, SCREEN W/LIP 11.00" X #8
53	F91151006	2	BELTING, 1-PLY .06 X 6.00 X 6.88"
52	F90008270	16	BALL TRAY WLDMT, 26.25 X 54.00" NG
51	F83453402	417	SMS, PHP PAN HD #8 X 3/4"
50	F83440135	12	SCW, SMS PAN HD #10 X 1.75"
49	F83200011	74	RIVET, POP SDS564 .188X.125-.250
48	F82400002	20	NAIL, 14 GA X 3/4" THRD, 7/32" HD T304SS
47	F80026101	1280	BALL, RUBBER 1 3/8" BLACK
46	F69681359	1	END, DISCH SPOUT, BTM SHOE II 968
45	F69681358	1	SPOUT, BOTTOM DISCHARGE 768-968
44	F69681356	3	DEFLECTOR II 768-968
43	F69681353	1	SHOE BTM MTL I, BTM SHOE II 968
42	F69681349	1	CROSS BOARD W/.06 X .81 NOTCH, 7" 768-968
41	F69681294	2	EXTENSION, DISCHARGE SPOUT, 968
40	F69681267	1	CROSS BOARD 7" 768-968
39	F69681265	1	SCREEN BLANK 18 X 54 W/LIP
38	F69681264	6	SPOUT, SPLIT DISCHARGE 768-968
37	F69681263	2	END, DISCHARGE SPOUT, 768-968
36	F69681262	2	SPOUT, DISCHARGE 7 DEG, 768-968
35	F69681260	3	DEFLECTOR I 768-968
34	F69681256	1	SHOT BTM MTL II, TOP SHOE 968
33	F67681442	2	BACK PLATE, SIDE SPUT, FNT 768MC
32	F67681441	2	BACK PLATE, SIDE SPUT, FNT 768MC
31	F67681440	2	SPOUT, 768MC REAR SHOE SIDE
30	F67681439	2	SPOUT, 768MC FRONT SHOE SIDE
29	F67681438	2	DIVIDER, CATCHALL 768MC
28	F67681437	2	BACK PLATE, CATCHALL 768MC
27	F67681436	2	CATCHALL, SIDE SPOUT 768MC
26	F67681430	2	SPOUT, SIDE W/DOOR ASSY, BTM SHOE 768MC
25	F67681426	1	SHOE BTM MTL II, BTM SHOE 768MC
24	F67681424	1	SHOE BTM MTL IV, BTM SHOE 768MC
23	F67681408	1	SHOE, BACK SIDE, BOTTOM SHOE ASSY, 768 MC
22	F67681407	1	SHOE, FRONT SIDE, BOTTOM SHOE ASSY, 768 MC
21	F67681406	1	SHOE, RIGHT SIDE, BOTTOM ASSY 768MC
20	F67681405	1	SHOE, LEFT SIDE, BOTTOM ASSY 768MC
19	F62241560	1	SPLTTR ASSY/WLDMT 25/75 #3 #8X9" SC4HC
18	F62241464	1	SUPPORT ANGLE, BTM SHOE, TITAN
17	F62241211	1	SPLITTER WLDMT, 25/75 2ND, #8X9.00" HI-CAP
16	F62241210	1	SPLITTER WLDMT, 25/75 1ST, #8X9.00" HC
15	F61001208	10	BOARD, CROSS 5.00 X 55.75"
14	F61001200	1	PITMAN WLDMT, 55.75"
13	F61001102	3	BOARD, CROSS INTERNAL 2.50 X 54.25"
12	F10808000	12	BLANK ASSY, SCREEN W/LIP 26.25 X 54.00"
11	F10516010	1	BLANK ASSY, SCREEN W/LIP 9.50 X 54"
10	F03805600	2	RUBBER HOLD-DOWN STRIP, 6.75"
9	F03500800	22	SCREEN HOOK ASSY, STANDARD
8	F03108906	1	BOARD, CROSS W/.06 X .81 NOTCH, 3.00 X 55.75"
7	F03108904	1	BOARD, CROSS 3.00 X 55.75" 2248D
6	70010521	43	SCW, DECK FLT HD #6 X 2.00"
5	66445200	12	WASHER, LOCK HELICAL 1/2"
4	66443300	24	WASHER, LOCK HELICAL 1/4"
3	66083300	24	NUT, HEX 1/4-20
2	62585226	12	HHCS, 1/2-13 X 1.25"
1	60283326	24	BOLT, CARR 1/4-20 X 1.25"

This drawing is the property of the A.T. Ferrell Company, Inc. and must be returned immediately upon request. No part of this drawing may be reproduced, stored in a retrieval system or transmitted in any form or by any means, without prior written consent of the A.T. Ferrell Company, Inc.

CAD NO MANUAL CHANGES TOLERANCES EXCEPT AS NOTED			
FINISH: 1:8 SCALE: 1:8 DRAWN BY: sahamman APPROVED BY: DJ	DIVISION OF A. T. FERRELL COMPANY BLUFFTON, INDIANA - USA		
TITLE: SHOE ASSY, BOTTOM, 768MC DATE: 5/21/2009 SIZE: D PART NUMBER: F67681401	SHEET: 7 of 8		

REVISION HISTORY			
REV	ECN	DESCRIPTION	APPROVED
A	F100171	REDRAWN IN INVENTOR, UPDATED ASSY	SH

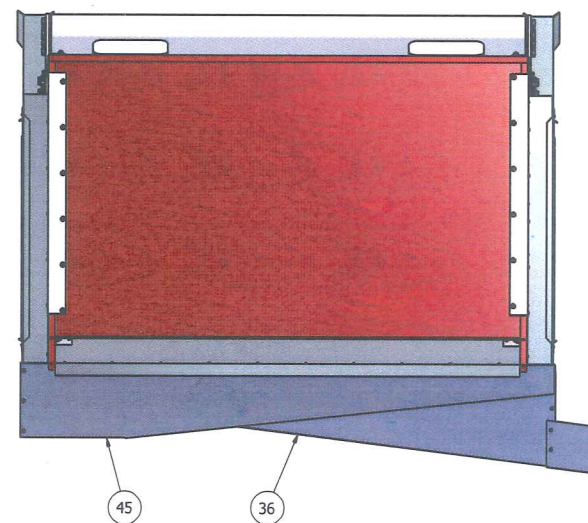
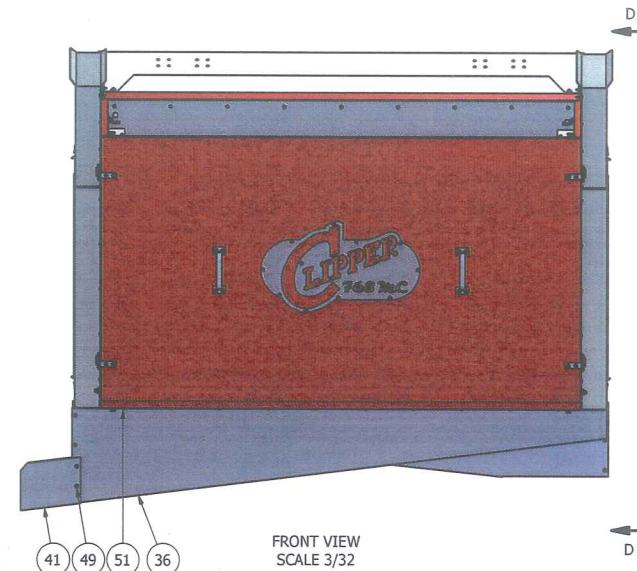
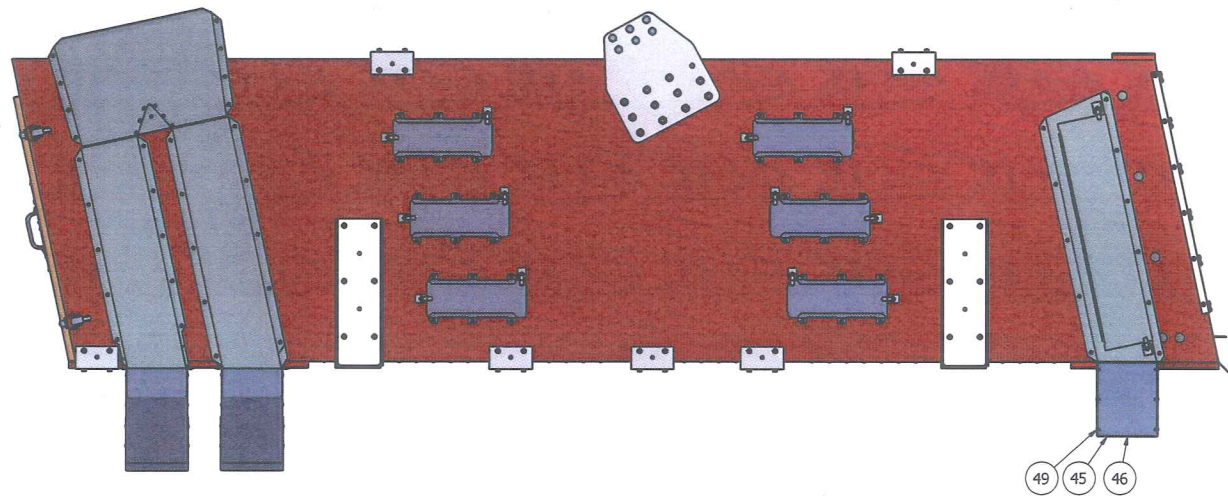
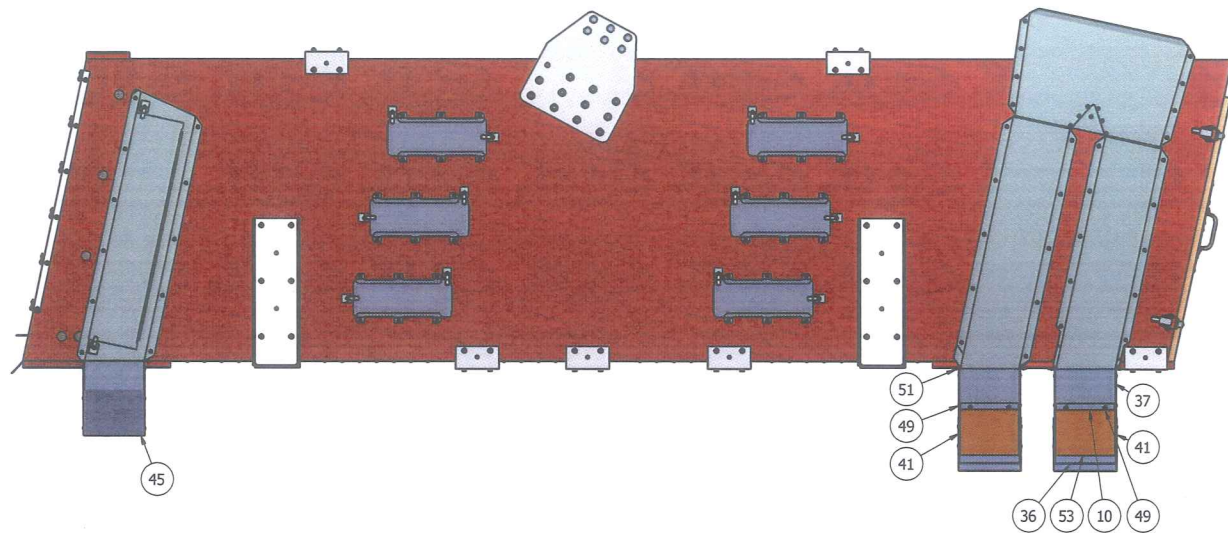

57	SALES ORDER	16	26" SCREEN W/LIP
56	F98600005	4	LATCH SET, 2PC SCD20649SS-M/SCD2065012ZE
55	F92053390	1	SCREEN BLANK ASSY, 9X54" W/LIP
54	F92053018	1	BLANK ASSY, SCREEN W/LIP 11.00" X #8
53	F91151006	2	BELTING, 1-PLY .06 X 6.00 X 6.88"
52	F90008270	16	BALL TRAY WLDMT, 26.25 X 54.00" NG
51	F83453402	41.7	SMS, PHP PAN HD #8 X 3/4"
50	F83440135	12	SCW, SMS PAN HD #10 X 1.75"
49	F83200011	74	RIVET, POP SDS64 .188X.125-.250
48	F82400002	20	NAIL, 14 GA X 3/4" THRD, 7/32" HD T304SS
47	F80026101	1280	BALL, RUBBER 1 3/8" BLACK
46	F69681359	1	END, DISCH SPOUT, BTM SHOE II 968
45	F69681358	1	SPOUT, BOTTOM DISCHARGE 768-968
44	F69681356	3	DEFLECTOR II 768-968
43	F69681353	1	SHOE BTM MTL I, BTM SHOE II 968
42	F69681349	1	CROSS BOARD W/.06 X .81 NOTCH, 7" 768-968
41	F69681294	2	EXTENSION, DISCHARGE SPOUT, 968
40	F69681267	1	CROSS BOARD 7" 768-968
39	F69681265	1	SCREEN BLANK 18 X 54 W/LIP
38	F69681264	6	SPOUT, SPLIT DISCHARGE 768-968
37	F69681263	2	END, DISCHARGE SPOUT, 768-968
36	F69681262	2	SPOUT, DISCHARGE 7 DEG, 768-968
35	F69681260	3	DEFLECTOR I 768-968
34	F69681256	1	SHOT BTM MTL II, TOP SHOE 968
33	F67681442	2	BACK PLATE, SIDE SPUT, FNT 768MC
32	F67681441	2	BACK PLATE, SIDE SPUT, FNT 768MC
31	F67681440	2	SPOUT, 768MC REAR SHOE SIDE
30	F67681439	2	SPOUT, 768MC FRONT SHOE SIDE
29	F67681438	2	DIVIDER, CATCHALL 768MC
28	F67681437	2	BACK PLATE, CATCHALL 768MC
27	F67681436	2	CATCHALL, SIDE SPOUT 768MC
26	F67681430	2	SPOUT, SIDE W/DOOR ASSY, BTM SHOE 768MC
25	F67681426	1	SHOE BTM MTL II, BTM SHOE 768MC
24	F67681424	1	SHOE BTM MTL IV, BTM SHOE 768MC
23	F67681408	1	SHOE, BACK SIDE, BOTTOM SHOE ASSY, 768 MC
22	F67681407	1	SHOE, FRONT SIDE, BOTTOM SHOE ASSY, 768 MC
21	F67681406	1	SHOE, RIGHT SIDE, BOTTOM SHOE ASSY, 768MC
20	F67681405	1	SHOE, LEFT SIDE, BOTTOM SHOE ASSY, 768MC
19	F62241560	1	SPLTR ASSY/WLDMT 25/75 #3 #8X9" SC4HC
18	F62241464	1	SUPPORT ANGLE, BTM SHOE, TITAN
17	F62241211	1	SPLITTER WLDMT, 25/75 2ND, #8X9.00" HI-CAP
16	F62241210	1	SPLITTER WLDMT, 25/75 1ST, #8X9.00" HC
15	F61001208	10	BOARD, CROSS 5.00 X 55.75"
14	F61001200	1	PITMAN WLDMT, 55.75"
13	F61001102	3	BOARD, CROSS INTERNAL 2.50 X 54.25"
12	F10808000	12	BLANK ASSY, SCREEN W/LIP 26.25 X 54.00"
11	F10516010	1	BLANK ASSY, SCREEN W/LIP 9.50 X 54"
10	F03805600	2	RUBBER HOLD-DOWN STRIP, 6.75"
9	F03500800	22	SCREEN HOOK ASSY, STANDARD
8	F03108906	1	BOARD, CROSS W/.06 X .81 NOTCH, 3.00 X 55.75"
7	F03108904	1	BOARD, CROSS 3.00 X 55.75" 2248D
6	70010521	43	SCW, DECK FLT HD #6 X 2.00"
5	66445200	12	WASHER, LOCK HELICAL 1/2"
4	66443300	24	WASHER, LOCK HELICAL 1/4"
3	66083300	24	NUT, HEX 1/4-20
2	62585226	12	HHCS, 1/2-13 X 1.25"
1	60283326	24	BOLT, CARR 1/4-20 X 1.25"

NOTES:
 1. DO NOT SCALE FROM DRAWING.
 2. LEFT HAND DISCHARGE SHOWN, ASSEMBLE DISCHARGE OPPOSIT FOR RIGHT HAND.

This drawing is the property of the A.T. Ferrell Company, Inc and must be returned immediately upon request. No part of this drawing may be reproduced, stored in a retrieval system or transmitted in any form or by any means, without prior written consent of the A.T. Ferrell Company, Inc

CAD
 NO MANUAL CHANGES
 TOLERANCES EXCEPT AS NOTED

DECIMAL: .005
 .030
 FRACTIONAL: 1/32
 ANGULAR: 1/2"

FINISH: DIVISION OF A. T. FERRELL COMPANY
 SCALE: 1:8
 DRAWN BY: sahamman
 APPROVED BY: DJ

TITLE: SHOE ASSY, BOTTOM, 768MC
 DATE: 5/21/2009
 SIZE: D
 PART NUMBER: F67681401
 SHEET: 8 of 8